

2024

CERAMIC
AND STONE
INSTALLATION
TOOLS

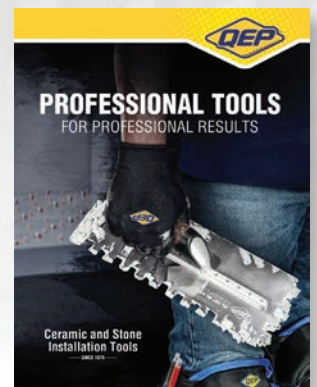

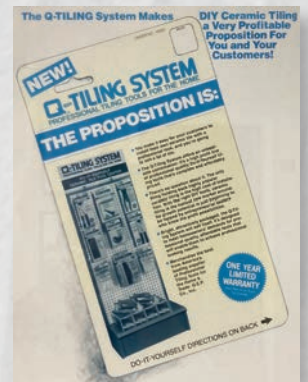
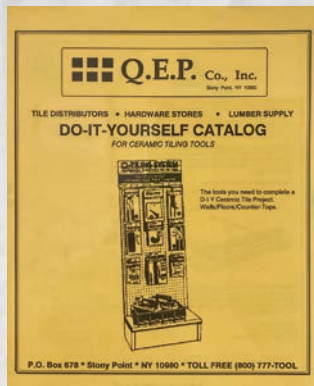

QEP was founded in 1979 with a vision of excellence in tile installation tools and impeccable timing: At the rise of Home Improvement Industry, and the boom of the DIY movement.

Through innovation and ingenuity, QEP is today the #1 Tile Tool Brand world-wide.

A trusted brand for the world's largest retailers and professional distributors, we continue to expand our product line with best-in-class product design, eco-friendly packaging, and optimal trend merchandising.

Recently introducing QEP Xtreme™, a premier line of tools developed and engineered for the professional installer with unique design elements, cutting-edge features, and long-range innovation, QEP is raising the bar in innovation and performance.

An iconic Brand, you can find QEP Tile Tools in over 100 Countries around the world, everywhere professional tools are sold.

CONTENTS

TROWELS & FLOATS

04

TILE SPACERS

TILE LEVELING SYSTEMS, HORSESHOE SHIMS, TRADITIONAL & LEAVE-IN SPACERS

09

INSTALLATION & BACKERBOARD TOOLS

MIXERS, NIPPERS, HOLE SAWS, SUCTION CUPS, FILES, MALLETS, GROUT SAWS, SPONGES, KNIVES, SEAM TAPE, BACKERBOARD

17

TILE CUTTERS

CUTTERS, SCORING WHEELS, RAIL SYSTEMS

37

TILE SAWS & DIAMOND BLADES

46

TEAR-OUT TOOLS

SCRAPERS

55

KNEE PADS

59

UNDERLAYMENTS & BARRIERS

CORK, AQUABAR®

62

DISPLAYS & MERCHANDISING

GONDOLAS, COUNTER DISPLAYS, GRAVITY DISPLAYS, FLOOR DISPLAYS

66

INDEX

70



TROWELS & FLOATS

QEP boasts an extensive offering of Trowels and Floats. With a variety of grips, sizes and designs, QEP makes it easy to find the right products for your tile installation project. Favorites of professional installers include the QEP Xtreme Pro Series Cork Handle Notched Trowels, QEP Margin Trowels and Floats, which feature bucket hooks for easy storage, and the QEP Extreme Pro Series Stone Grout Float, shaped to contour and flex giving you the leverage you need.

X-TREME PRO-SERIES Cork Handle Trowels

- 25% longer blade life with reinforced exposed rivets for added strength
- Extra handle-to-shank distance allows maximum hand clearance
- Rustproof 12" x 4-1/2" stainless steel blade designed for long lasting durability
- Cork comfort grip for better cushion and anti-slippage in the hand



#1 PROVEN PERFORMANCE
LONGEST LASTING
BLADE IN THE INDUSTRY*

Item No.	Description	Case Qty	Packaging
49950-12	Xtreme Cork Handle Trowel Square Notch 1/4" x 1/4" x 1/4"	12	Shelf Case
49951-12	Xtreme Cork Handle Trowel Square Notch 1/4" x 3/8" x 1/4"	12	Shelf Case
49952-12	Xtreme Cork Handle Trowel Square Notch 1/2" x 1/2" x 1/2"	12	Shelf Case
QEP Canada Only			
49953-12	Xtreme Cork Handle Trowel with ruler Square Notch 1/4" x 1/4" x 1/4"	12	Shelf Case
49954-12	Xtreme Cork Handle Trowel with ruler Square Notch 1/4" x 3/8" x 1/4"	12	Shelf Case
49955-12	Xtreme Cork Handle Trowel with ruler Square Notch 1/2" x 1/2" x 1/2"	12	Shelf Case

*3rd Party independent testing performed by CARTA

Comfort Grip Stainless Steel Trowels

- High quality 11" x 4-1/2" trowel designed for the professional
- Durable 230 mm aluminum die-cast shank
- Rustproof stainless steel blade
- Longer shank with 9 rivets
- Extra handle-to-shank clearance to allow for complete hand rotation
- Large, contoured and cushioned grip handles for comfort
- First and last rivet reinforced and welded



#1 PROVEN PERFORMANCE
LONGEST LASTING
BLADE IN THE INDUSTRY*

Item No.	Description	Case Qty	Packaging
49915-12	Comfort Grip Stainless Steel Trowel Square Notch 1/4" x 1/4" x 1/4"	12	Shelf Case
49916-12	Comfort Grip Stainless Steel Trowel Square Notch 1/4" x 3/8" x 1/4"	12	Shelf Case
49917-12	Comfort Grip Stainless Steel Trowel V Notch 3/16" x 5/32"	12	Shelf Case
49919-12	Comfort Grip Stainless Steel Trowel Square Notch 1/2" x 1/2" x 1/2"	12	Shelf Case

*3rd Party independent testing performed by CARTA

Wood Handle Trowels

- Quality 11" x 4-1/2" trowel designed for the professional installer
- Large wooden handle for an easy grip
- Hardened and tempered steel blade, ground and polished or long lasting durability
- Aluminum die-cast shank



Item No.	Description	Case Qty	Packaging
49713	Wood Handle Trowel Square Notch 1/4" x 1/4" x 1/4"	12	Shelf Case
49714	Wood Handle Trowel Square Notch 1/4" x 3/8" x 1/4"	12	Shelf Case
49716	Wood Handle Trowel V Notch 1/4" x 3/16"	12	Shelf Case
49720	Wood Handle Trowel Square Notch 1/2" x 1/2" x 1/2"	12	Shelf Case

Standard Trowels



- Quality trowel measuring 9" x 4"
- Hard, cold-rolled steel blade for longer wear
- High-impact black plastic handle



Item No.	Description	Case Qty	Packaging
10113	Standard Trowel Square Notch 1/4" x 1/4" x 1/4"	30	Shelf Case
10114	Standard Trowel Square Notch 1/4" x 3/8" x 1/4"	30	Shelf Case
10115	Standard Trowel V Notch 3/16" x 5/32"	30	Shelf Case
10120	Standard Trowel Square Notch 1/2" x 1/2" x 1/2"	30	Shelf Case
QEP Canada Only			
10116	Standard Trowel V Notch 1/4" x 3/16"	30	Shelf Case

Benefits of Cork Trowels



A favorite of installers, trowels with cork handles harness the natural moisture repellent properties of cork to provide a secure grip even with wet hands. Sustainable and naturally ergonomic, cork handles contribute to minimize fatigue and are easy to cleanup.

Notched Trowels at a glance

Notch Size	Application	X-TREME Cork Handle (12" Blade)	Comfort Grip (11" Blade)	Wood Handle (11" Blade)	Standard (9" Blade)
3/16" x 5/32" V	For plastic, wall, ceramic & metal tile 6" x 6" or smaller and mosaics on drywall. Also for wall base.		49917-12		10115
1/4" x 3/16" V	For ceramic, metal & aluminum wall tile 6" x 6" up to 12" x 12"			49716	10116 Canada Only
1/4" x 1/4" x 1/4" SQ	For thinset application of ceramic tile 8" x 8" or smaller, laminated wood plank flooring, flat milled solid & shorts or plywood	49950-12 49953-12 Canada Only	49915-12	49713	10113
1/4" x 3/8" x 1/4" SQ	Thinset application of ceramic tile 8" x 8" up to 16" x 16"	49951-12 49954-12 Canada Only	49916-12	49714	10114
1/2" x 1/2" x 1/2" SQ	Thinset or medium bed mortar application of natural stone, quarry tile, pavers, saltillo and ceramic tiles 12" x 12" and larger	49952-12 49955-12 Canada Only	49919-12	49720	10120

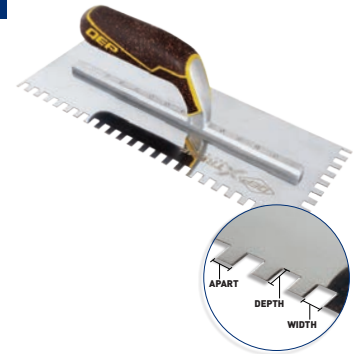

Always check adhesive/mortar manufacturer's trowel recommendations before selecting a trowel notch.

All Trowels Measure:
Width x Depth x Space Apart

Recommended notch sizes by NTCA
(National Tile Contractors Association)

Patch & Finishing Trowel



- For leveling, patching and finishing
- Hardened, tempered, ground and polished steel blade
- Die-cast aluminum shank with wood handle

Item No.	Description	Case Qty	Packaging
49708	Patch & Finishing Trowel 11" x 4-1/2" No Notch	12	Shelf Case

Margin Trowel



- Enlarged 6" x 2" blade is made from ground, tempered and hardened steel for flexibility and durability
- Patent pending bucket hook for easy storage on the side of your bucket
- Co-molded plastic handle with non-slip, rubber grip for comfortable repeat use

Item No.	Description	Case Qty	Packaging
42112	6" x 2" Comfort Grip Margin Trowel No Notch	12	Shelf Case
42114	6" x 2" Comfort Grip Margin Trowel Square Notch 1/4" x 1/4" x 1/4"	12	Shelf Case

Bucket Scoop



- Efficiently scoop setting materials, stucco and more
- Large comfort grip, contoured cushion handle
- 33% longer blade to hold more material
- Curved blade fits 5 gallon buckets
- Stainless steel blade

Item No.	Description	Case Qty	Packaging
42113	Bucket Scoop	6	Hang Card

Bucket Scoop

**AVAILABLE
SUMMER 2024**



- New Design! Scoops all setting material from sides and bottom of 5 gallon bucket
- Patent pending bucket hook for easy storage on the side of your bucket
- Improved contoured cushion handle provides better angle and flexibility
- Stainless steel blade

Item No.	Description	Case Qty	Packaging
42113-6	Bucket Scoop	6	Hang Card

Universal Grout Float



- Non-stick gum rubber ensures smooth application for all grout types including epoxy
- 2-rounded corners prevent gouging of grout joints
- 2-square corners ensure complete grout coverage in corners
- Extra thick aluminum backing plate for maximum leverage and applying grout into joints.
- Comfortable, contoured and cushioned grip handle

Item No.	Description	Case Qty	Packaging
10074-8	Universal Grout Float 9-1/2" x 4"	8	Shelf Case

X-TREME PRO-SERIES Stone Grout Float

For all grout types, including epoxy

PRECISION SQUARED CORNERS
Ensure complete coverage in corners



PRECISION ROUND CORNERS
Prevent gouging of grout joints

- Soft body design provides maximum flex and leverage for working grout into tile joints, with sanded and non-sanded grouts, for textured tile and natural stone
- Inner aluminum backing plate offers strength and stability
- Squared corners ensure complete coverage in corners

Item No.	Description	Case Qty	Packaging
10069	Xtreme Stone Grout Float, 10" x 3-1/2"	12	Shelf Case

SCAN HERE FOR MORE PRODUCT INFORMATION



Gum Rubber Grout Float



- Non-stick gum rubber ensures smooth application
- 2-rounded corners prevent gouging of grout joints
- 2-square corners ensure complete grout coverage in corners
- Extra thick aluminum backing plate for maximum leverage and applying grout into joints
- Premium gum rubber laminated to lightweight, closed cell core is built to last

Item No.	Description	Case Qty	Packaging
10070	Gum Rubber Grout Float, Wood Handle, 10-1/2" x 4"	12	Shelf Case

Molded Rubber Grout Float



- Non-stick 5/8" molded gum rubber pad prevents absorption of materials
- Aluminum back plate for durability and beveled sides for a smooth application

Item No.	Description	Case Qty	Packaging
10060	Molded Rubber Grout Float 9-1/2" x 4"	12	Shelf Case

Grout Float



- High-impact plastic handle with closed cell foam rubber pad for a smooth application

Item No.	Description	Case Qty	Packaging
10062	Grout Float 9" x 4"	24	Shelf Case

Margin Float



- Ideal for hard-to-reach areas such as kitchen backsplashes or under bath and kitchen counters
- Enlarged 6" x 2" gum rubber pad with tempered and hardened steel backing plate
- Patent pending bucket hook for easy storage on the side of your bucket
- Co-molded plastic handle with non-slip, rubber grip

Item No.	Description	Case Qty	Packaging
42117	6" Comfort Grip Margin Float	12	Shelf Case



TILE SPACERS

QEP offers a variety of systems and spacer styles to eliminate tile lippage. The original LASH® Tile Leveling System, LASH® 360 Tile Leveling System and Xtreme™ Pro Series Tile Leveling System are two-part clip & wedge systems to eliminate uneven tiles. Our horseshoe shims, flexible tile spacers, hard tile spacers, and "T" tile spacers are all solid options for aligning floor and wall tile based on your installation preferences.

XTREME PRO-SERIES Tile Leveling System

Extra wide, flat base design is ideal for large format tile installations

**Wide
Format
Design**



- Two part system eliminates uneven tiles
- Available in 4 grout widths
- For tiles up to 1/2" thick
- Easy to use, especially with large format tile

Item No.	Description	Qty	Case Qty	Packaging
99771	Xtreme 1/32" Leveling Clips, Box	500	8	Shelf Case
99776	Xtreme 1/32" Leveling Clips, Box	2000	1	Shelf Case
99761	Xtreme 1/16" Leveling Clips, Bag	100	8	Shelf Case
99772	Xtreme 1/16" Leveling Clips, Bag	500	8	Shelf Case
99777	Xtreme 1/16" Leveling Clips, Box	2000	1	Shelf Case
99769	Xtreme 1/8" Leveling Clips, Bag	100	8	Shelf Case
99773	Xtreme 1/8" Leveling Clips, Box	500	8	Shelf Case
99778	Xtreme 1/8" Leveling Clips, Box	2000	1	Shelf Case
99774	Xtreme 3/16" Leveling Clips, Box	500	8	Shelf Case
99779	Xtreme 3/16" Leveling Clips, Box	2000	1	Shelf Case
99762	Xtreme Leveling Wedges, Bag	100	8	Shelf Case
99775	Xtreme Leveling Wedges, Box	500	8	Shelf Case
99780	Xtreme Leveling Wedges, Box	2000	1	Shelf Case

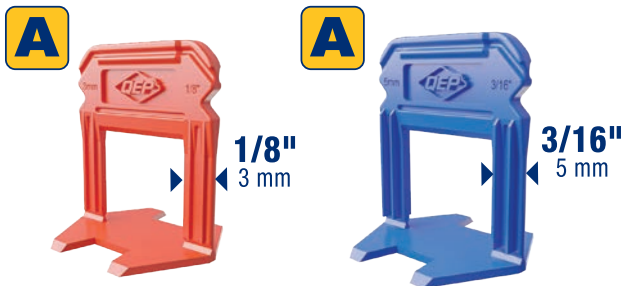

B

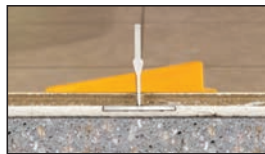

For faster installation use
QEP Pro Installation Pliers

Pro Installation Pliers



- Insert clips with less effort
- Easily sets the wedge into the clip, and comfortably applies the right amount of pressure without overtightening
- Easily adjusts for different tile thickness
- Reversible caps for use with larger leveling systems
- Use with QEP LASH, as well as QEP Xtreme Tile Leveling Systems for faster installation
- Stop pin regulates proper pressure at all times
- Co-molded plastic handle with non-slip, rubber grip for comfortable repeat use

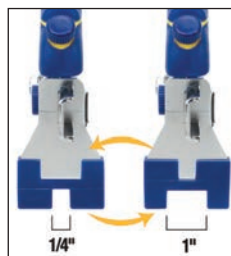

Item No.	Description	Case Qty	Packaging
99784	Pro Installation Pliers	6	Hang Card
QEP Canada Only			
99784C	Pro Installation Pliers	6	Hang Card

X-TREME PRO-SERIES Tile Leveling Clips and Wedges Pallets

X-TREME PRO-SERIES Tile Leveling Clips and Wedges in Pallet quantities

**Large Format Design for tiles up to 1/2" thick
Available in 4 grout widths**



**SAVE
15%
ON PALLET
QUANTITIES**

X-TREME PRO-SERIES Tile Leveling Clips and Wedges – 500 Count



16
cases
500 count clips
per pallet



4
cases
500 count
wedges
per pallet

Order the following to fill pallets:
500 count clips: 16 boxes – 500 count wedges: 4 boxes
See page 10 for details on each sku

X-TREME PRO-SERIES Tile Leveling Clips and Wedges – 2000 Count



24
boxes
2000 count clips
per pallet



12
boxes
2000 count
wedges
per pallet

Order the following to fill pallets:
2000 count clips: 24 boxes – 2000 count wedges: 12 boxes
See page 10 for details on each sku

LASH® 360 Tile Leveling System

LASH® 360

LEVEL ALIGN SPACE HOLD

Tile Leveling System - 48 Count Boxes

Order the following to fill pallets:

96 count Caps: 24 boxes – 240 count Stems: 24 boxes

Cap and In-line Stem both on one pallet!



99734



99735



**SAVE
10%
ON PALLET
QUANTITIES**

500 2000 PACKS

X-TREME PRO-SERIES TILE LEVELING SYSTEM IN EXTRA LARGE PRO PACKS
FROM THE INVENTOR OF THE ORIGINAL LASH



Xtreme Tile Leveling System
with larger format clips and wedges.
Available in sizes 1/32", 1/16", 1/8", 3/16"
and contractor quantities of 500 or 2000

LASH® 360 Tile Leveling System

NEW

Install large format porcelain, ceramic and all natural stone tile up to 3/4" thick with the LASH® 360 Tile Leveling System

LASH® 360
LEVEL ALIGN SPACE HOLD

- No tools necessary
- Available in 3 Formats to work with any tile layout
- Stems provide 1/16" grout lines
- Save time while providing a level and consistently spaced wall or floor
- Cap design provides view of the group joints
- Caps can be removed and reused

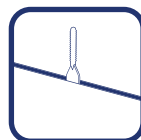
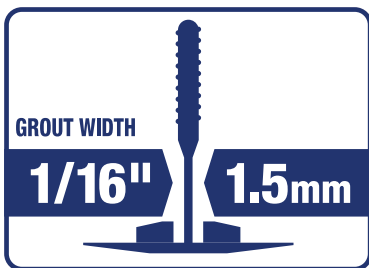

In-line



3 Corner

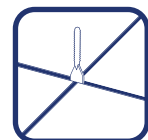

4 Corner



Item No.	Description	Qty	Case Qty	Packaging
99734	LASH 360 Caps, Bag	100	4	Shelf Case
99735	1/16" LASH 360 In-line, Bag	100	10	Shelf Case
99736	1/16" LASH 360 3-Corner, Bag	100	10	Shelf Case
99737	1/16" LASH 360 4-Corner, Bag	100	10	Shelf Case

SCAN HERE FOR MORE PRODUCT VIDEO



Tile Leveling System



For perfect tile-to-tile leveling

The patented LASH® Tile Leveling System is designed for quick installation and reduces costly call backs by ensuring that the finished floor surface is lippage-free. This time-saving system helps adjust the height of the tiles and evenly holds their edges throughout the curing process of the setting material.

- For use with all floor and wall tiles between 1/4" and 7/16" thick
- Durable nylon construction for a secure installation
- Specially designed break-off point on clips for swift removal
- Produces 1/16" or 1/8" joint spacing
- May be combined with regular tile spacers for wider joints - up to 1/4"
- Wedges are reusable



Item No.	Description	Qty	Case Qty	Packaging
99730	1/16" LASH® Clips, Bag	100	8	Shelf Case
99731	1/16" LASH® Clips, Box	300	4	Shelf Case
99740	1/16" LASH® Clips, Box	1000	1	Shelf Case
99707Q	1/16" LASH® Clips, Box	4800	1	Contractor Pack
99781	1/8" LASH® Clips, Bag	100	8	Shelf Case
99782	1/8" LASH® Clip, Box	300	4	Shelf Case
99783	1/8" LASH® Clips, Box	1000	1	Shelf Case
99726	LASH® Wedges, Bag	100	8	Shelf Case
99727	LASH® Wedges, Bag	300	4	Shelf Case
99703	LASH® Wedges, Box	3600	1	Contractor Pack

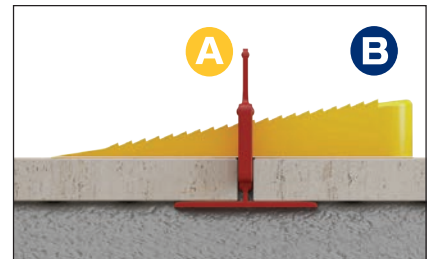
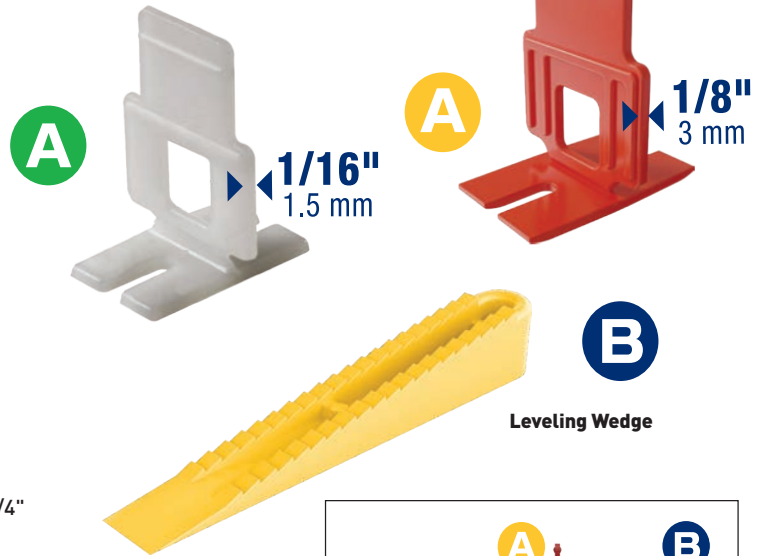

LASH® Flat Clip for Floor and Wall Tiles



For faster installation use GEP Pro Installation Pliers. See page 10 for details.

Horseshoe Shims



- Ideal for marble, granite, stone, large format tiles and vertical installations.
- Allows user to lift both corners and align the joints from tile to tile
- Non-compressive

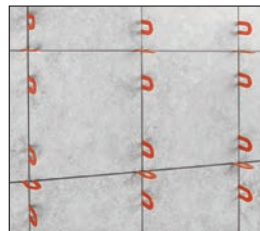

Packaged in reusable storage container

Item No.	Description	Case Qty	Packaging
10320	1/16" Horseshoe Shims - 200 Qty	6	Tub
10321	1/8" Horseshoe Shims - 150 Qty	6	Tub
10322	3/16" Horseshoe Shims - 100 Qty	6	Tub
10323	1/4" Horseshoe Shims - 75 Qty	6	Tub

Wedge Tile Spacers



- Crucial for achieving a level first row of wall tile
- Ideal for maintaining level horizontal grout lines during installation
- Avoids tile slippage on vertical surfaces - will not compress
- Can be used for up to 1/8" (3 mm)



Item No.	Description	Case Qty	Packaging
10285	Wedge Tile Spacers, Bag - 500 Qty	16	Hang Card Shelf Case

Traditional, Flexible Tile Spacers

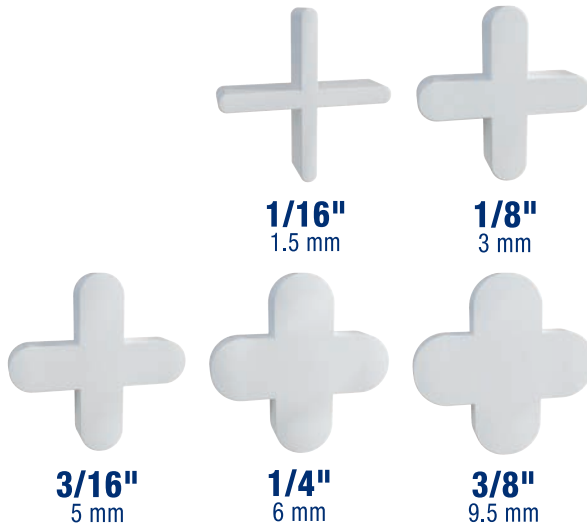

- Works with ceramic tile, porcelain, stone and marble
- Flexible, soft plastic design for easy maneuvering in tile joints
- Evenly space tiles for uniform grout lines
- For easy removal, use spacers vertically in traditional tombstone-style



Item No.	Description	Case Qty	Packaging
10334	1/16" Tile Spacers*, Bag - 300 Qty	24	Shelf Case
10335	1/8" Tile Spacers*, Bag - 500 Qty	14	Shelf Case
10336	3/16" Tile Spacers*, Bag - 300 Qty	14	Shelf Case
10005	1/4" Tile Spacers*, Bag - 200 Qty	15	Shelf Case
10027	3/8" Tile Spacers*, Bag - 100 Qty	20	Shelf Case

***Not recommended for large format wall tiles over 15"**

"T" Tile Spacers

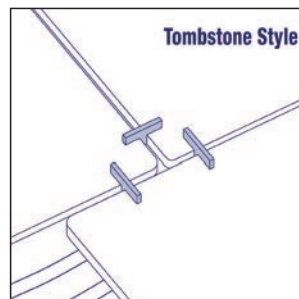
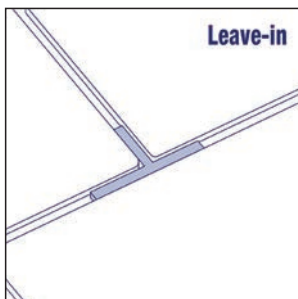

- For aligning all floor and wall tiles
- Designed for Subway, brick layout or any offset tiling patterns and perimeters
- Will not compress when setting marble, granite, stone and large format tile
- Use in traditional "tombstone" style or leave between tiles and grout over
- Support bar and extended solid tip for improved tile support, keeping the spacer from compressing
- Longer leg length for easier installation



Item No.	Description	Case Qty	Packaging
10202	1/16" "T" Tile Spacers, Bag - 300 Qty	24	Hang Card Shelf Case
10203	1/8" "T" Tile Spacers, Bag - 300 Qty	20	Hang Card Shelf Case
10204	3/16" "T" Tile Spacers, Bag - 200 Qty	14	Hang Card Shelf Case

Hard, Leave-in Tile Spacers

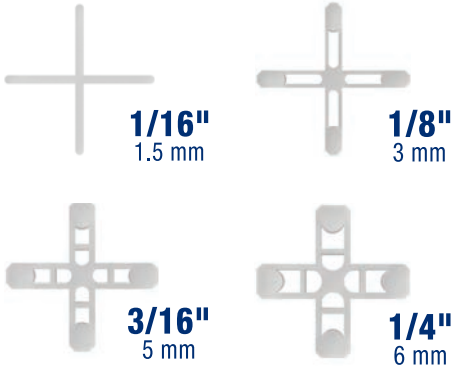

- Will not compress when setting marble, granite, stone and large format tile
- Use as traditional vertical tombstone-style or inset leave-in installation method
- Leave-In design reduces installation time
- Easy to handle, extra long prongs assure perfect 90° grout corners

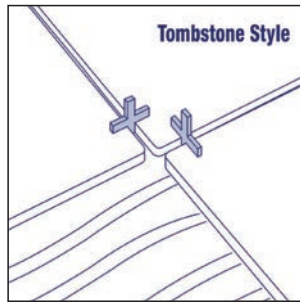
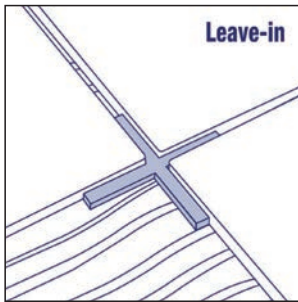

Item No.	Description	Case Qty	Packaging
10330-20	1/16" Leave-In Spacers, Bag - 300 Qty	20	Shelf Case
10331-18	1/8" Leave-In Spacers, Bag - 300 Qty	18	Shelf Case
10332	3/16" Leave-In Spacers, Bag - 200 Qty	12	Shelf Case
10333	1/4" Leave-In Spacers, Bag - 200 Qty	10	Shelf Case
10324	1/16" Leave-In Spacers, Jar - 1500 Qty	6	Shelf Case
10325	1/8" Leave-In Spacers, Jar - 1000 Qty	6	Shelf Case
10326	3/16" Tile Spacers, Jar - 500 Qty	6	Shelf Case

Paver Spacers

NEW



- Spacer is 2-1/2" across
- Easy to conceal- Transparent for better concealment in grass or sand installations
- Easy Installation- Easy to handle, leave in design, reduces installation time
- Versatile- for easy installation of pavers over sand, gravel and grass
- Designed with convenient break off tabs for aligning staggered pavers



Item No.	Description	Case Qty	Packaging
10451	1/8" Paver Spacers 20 pack	8	Shelf Case



INSTALLATION & BACKERBOARD TOOLS

QEP Mixers, Nippers, Sanding Blocks, Mallets, Grout Removers, Sponges, Hole Saws, Suction Cups, Gloves, Tape, Knives, Specialty Tools and more is what you will find in our Installation and Backerboard Tool assortment!

Power Mixer Pro

Designed to mix thinset, grout, mortar, and other viscous materials



- High torque powerful 1400 Watt motor
- 0-800 RPM variable speed dial to select appropriate speed
- Lock-on function keeps mixer at desired RPM without holding the trigger



Item No.	Description	Case Qty	Packaging
21700	Power Mixer Pro w/ Paddle	1	Color Carton
21661	24" Pro Mixing Paddle (Replacement)	1	Shelf Case

SPECIFICATIONS

Item No	21700
Motor	120 V ~ 1400 Watts 1st gear: 0-480 RPM 2nd gear: 0-800RPM
Amps	12-1/2
Weight	10-1/2 lbs

Includes 1/2" Chuck Kit



SCAN HERE FOR MORE PRODUCT INFORMATION

Pro Mixing Paddles

QEP offers a variety of mixing paddles for fast and effective mixing of grouts, thinsets and other setting materials

61230 - 30"

21661 - 24"

61205 - 23-1/2"

75001Q - 23-1/2"

61210 - 16"

Designed to reduce air in mixture

M-14 thread



Available in 30 count floor displays
61205D
see page 67

Fits in 1 Gallon Bucket

Item No.	Description	Blade Width	Case Qty	Packaging
61230	30" XL Spiral Pro Mixer	5-1/2"	6	Shelf Case
21661	24" Pro Mixing Paddle	5-1/2"	1	Shelf Case
61205	23-1/2" Pro Mixing Paddle	4-7/8"	8	Shelf Case
61205D	23-1/2" Pro Mixing Paddle Display	4-7/8"	30	Floor Display
75001Q	23-1/2" Thinset and Grout Mixing Paddle	8-1/4"	6	Shelf Case
61210	16" Universal Mixing Paddle	3-1/4"	12	Shelf Case

X-TREME PRO-SERIES Pro Control Glass Tile Nipper

Designed for cutting irregular shapes in glass tiles and mosaics up to 5/16" thick



- 7/8" titanium coated tungsten carbide cutting wheels for long lasting toughness and durability
- 3-position Tile Thickness Lock minimizes hand fatigue during repeat cutting of the same tile thicknesses

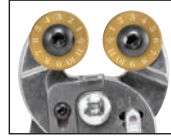

SharpTrack Cutting Wheels identify used cutting edges

Item No.	Description	Case Qty	Packaging
32014	Xtreme Pro Control Glass Tile Nipper	6	Hang Card

⚠WARNING: Cancer and Reproductive Harm- www.P65Warnings.ca.gov. See P. 67, *Prop 65 - 1.

SCAN HERE FOR MORE PRODUCT INFORMATION



Glass Tile Nipper



- Cuts irregular shapes in glass tile and mosaics from 1/32" to 1/4" thick
- Ideal for quickly cutting small mosaic pieces of glass and removing tiny points from glass tile
- Single piece, drop-forged steel construction for maximum strength with comfortable, contoured handles



Item No.	Description	Case Qty	Packaging
32010	Glass Tile Nipper	6	Hang Card

X-TREME PRO-SERIES Offset Tile Nipper

Steel construction with protective coating and tough, tungsten carbide tips for long lasting use

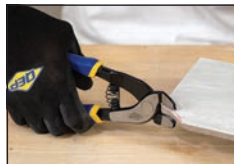

- Designed for cutting irregular shapes in ceramic and porcelain tile up to 5/16" thick
- Contoured, rubberized handle is more comfortable in the hand
- Offset tungsten carbide tips for more control when making irregular and curved cuts
- Helps fit tile around oddly-shaped objects, like pipes or sinks

Item No.	Description	Case Qty	Packaging
10103	Xtreme Offset Tile Nipper	6	Hang Card

⚠WARNING: Cancer and Reproductive Harm- www.P65Warnings.ca.gov. See P. 67, *Prop 65 - 1.

SCAN HERE FOR MORE PRODUCT INFORMATION



Compound Tile Nipper



- Compound mechanism delivers 3 times more force with less effort
- Use to cut irregular shapes in all tile from 1/8" to 1/4" thick
- Durable tungsten carbide tip provides a long cutting life
- Co-molded plastic handle with non-slip, rubber grip for comfortable repeat use

Item No.	Description	Case Qty	Packaging
32036	Compound Tile Nipper	6	Hang Card

Tile Nipper



- 8" carbide tipped nippers with offset jaws
- For cutting irregular shapes in tile from 1/8" to 1/4" thick
- Single piece, drop-forged steel construction for maximum strength

Item No.	Description	Case Qty	Packaging
10003	Tile Nipper	12	Hang Card

Tile Cutter



- Recommended for manually scoring and cutting ceramic wall tiles up to 6" x 6" and 1/4" thick
- Uses a durable tungsten carbide wheel for scoring and a breaker bar to "snap" ceramic tile

Item No.	Description	Case Qty	Packaging
32024	Tile Cutter	6	Hang Card

6" Locking Contour Gauge



Irregular shapes are locked into place

- Easily forms around any shape for a precise template, reducing waste created when guessing the dimension of irregular shapes
- Locking feature holds patterns in place while tracing on any surface
- Great for marking precise cutouts in vinyl, wood, porcelain and ceramic tiles

Item No.	Description	Case Qty	Packaging
10038	6" Locking Contour Gauge	1	Hang Card
QEP Canada Only			
10038C	6" Locking Contour Gauge	1	Hang Card

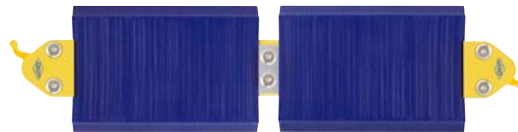

Combine 2 Gauges for longer profiles

Wax China Markers

2-Pack



- Ease to peel string, no need to sharpen
- For marking on hard, glossy, non-porous surfaces including porcelain, glass, ceramics or polished stone
- Resistant to moisture and easily wipes off all surfaces

Item No.	Description	Case Qty	Packaging
38779	Wax China Markers - 2 Pack - 1 black/1 red	12	Hang Card

Diamond Drill Bit with Water Delivery System



- Ideal for cutting holes when installing towel bars, soap dishes, shelves, cabinets and shower door frames
- Diamond Grit edge drills through ceramic, glass, marble, porcelain and granite
- Convenient, single piece water delivery system keeps hole saw cool for a longer life
- Fits standard 1/2" or 3/8" drill chucks
- Kit includes 6 adhesive pads, water cooling system, drill guide and drill bit
- Only for wet use with cordless drills



SUPERIOR BRAZED
DIAMOND BONDING

Item No.	Description	Case Qty	Packaging
10571	5/16" Porcelain Diamond Drill Bit w/Drill Guide and Water Cooling System	6	Hang Card
10572	1/4" Porcelain Diamond Drill Bit w/Drill Guide and Water Cooling System	6	Hang Card

⚠WARNING: Cancer and Reproductive Harm- www.P65Warnings.ca.gov. See P. 67, *Prop 65 - 1.

Diamond Hole Saw with Water Delivery System

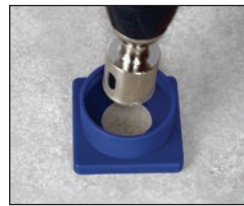

- For cutting 1-3/8" diameter holes in glass, ceramic, porcelain, marble and granite
- Special diamond grit edge for faster smoother cuts
- Included drill guide and water cooling cup easily supplies water to drill bit (use wet-only)
- Fits standard 1/2" or 3/8" drill chucks
- Includes 6 adhesive strips, water cooling cup and 1-3/8" diameter x 3" tall drill bit
- Only for wet use with cordless drills



SUPERIOR BRAZED
DIAMOND BONDING

Item No.	Description	Case Qty	Packaging
10569	1-3/8" Porcelain Diamond Hole Saw w/Drill Guide and Water Cooling System	6	Hang Card
10570	1-3/8" Hole Saw Extra Mounting Tape	6/cs (12 pc/bag)	Hang Card

3" Diamond Jigsaw Blade



- For cutting hard materials, including porcelain and ceramic tile
- Cuts faster and cleaner than standard carbide blades
- Heat treated alloy steel backer for superior strength



SUPERIOR BRAZED
DIAMOND BONDING

Item No.	Description	Case Qty	Packaging
10585	3" Diamond Jigsaw Blade	6	Hang Card

X-TREME PRO-SERIES Diamond Hole Saws

QEP's Diamond Hole Saws deliver fast and accurate wet or dry cutting of porcelain, stone, marble, ceramic, and glass tiles.

Tough and strong, these Diamond Hole Saws attach to drills, cutting with precision and good resistance to wear, making them ideal to use when installing fixtures, or working around pipes.

up to
12X
LONGER LIFE
than standard hole saws

X-TREME PRO-SERIES Diamond Hole Saws for Drills

For cutting holes in glass, ceramic, porcelain, marble and granite



- Advanced metallurgical technology bonds diamond grit to chrome alloy steel base to produce a long lasting cutting edge
- Extremely durable and built to last longer than conventional diamond drill bits and standard hole saws
- Simply dip in water, no need for a constant water delivery system, for quick and easy use
- Fits standard 1/2" or 3/8" drill chucks



Item No.	Description	Case Qty	Packaging
10071	Xtreme 3/16" Diamond Hole Saw	6	Hang Card
10075	Xtreme 1/4" Diamond Hole Saw	6	Hang Card
10080	Xtreme 5/16" Diamond Hole Saw	6	Hang Card
10087	Xtreme 1-3/8" Diamond Hole Saw	6	Hang Card



SCAN HERE FOR MORE PRODUCT INFORMATION

wax/DRY **X-TREME** PRO-SERIES Diamond Hole Saw Kit

For drilling all types of ceramic tile, porcelain, stone, marble and granite



- Convenient kit contains 4 size: 1/4", 5/16", 3/8" & 1/2" (6 mm, 8 mm, 10 mm, 12 mm)
- No constant water needed
- Ideal for placing bathroom accessories or any type of decoration accessory on ceramic surfaces
- Wax lubricant for cooling the diamond edge



Item No.	Description	Case Qty	Packaging
10485	wax/DRY Xtreme Diamond Hole Saw Kit	6	Hang Card

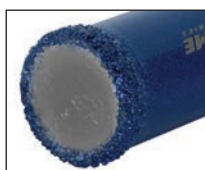

SCAN HERE FOR MORE PRODUCT INFORMATION

X-TREME PRO-SERIES Diamond Hole Saws for Angle Grinders

For fast, clean hole cutting in porcelain tile, ceramic tile, granite, marble and slate



up to
**50%
FASTER**
THAN A DRILL

- Last at least 12x longer than drill attachment
- Superior brazing technology ensures diamonds stay bonded
- No water cooling required on any sizes
- Wax lubricant for cooling the diamond edge (3/16", 1/4", 5/16" sizes)



Item No.	Description	Case Qty	Packaging
10468	Xtreme 3/16" Hole Saw for grinder	6	Hang Card
10469	Xtreme 1/4" Hole Saw for grinder	6	Hang Card
10470	Xtreme 5/16" Hole Saw for grinder	6	Hang Card
10471	Xtreme 1" Hole Saw for grinder	6	Hang Card
10472	Xtreme 1-3/8" Hole Saw for grinder	6	Hang Card
10473	Xtreme 2" Hole Saw for grinder	6	Hang Card
10474	Xtreme 2-1/2" Hole Saw for grinder	6	Hang Card
10475	Xtreme 4" Hole Saw for grinder	6	Hang Card



SCAN HERE FOR MORE PRODUCT INFORMATION

X-TREME PRO-SERIES Diamond Milling Bits & Cones

Designed to enlarge, shape and round bevel existing holes in porcelain, hard ceramic, granite and marble



- Works on all standard grinders, no adaptor necessary



Item No.	Description	Case Qty	Packaging
10051	Xtreme 3/8" Diamond Milling Bit	6	Hang Card
10052	Xtreme 3/4" Diamond Milling Bit	6	Hang Card
10066	Xtreme 1-1/2" Diamond Milling Cone	6	Hang Card



SCAN HERE FOR MORE PRODUCT INFORMATION

Suction Cups

QEP offers a wide array of suction cups for lifting large format tile. Heavy-duty options include single suction cup design, double suction cups and our newest addition, pump section cups for even more holding power. Let us do the heavy lifting!

XTREME PRO-SERIES 8" Electric Suction Cup

NEW

Hand held, portable tool for lifting large tiles, stone, glass, and more



- Built in air sensor provides steady suction with 48 hour non-stop running time
- Multi-layered sealed safety rim
- Digital LED display indicating battery life
- Rechargeable Lithium-ion battery (6-8 hours charging time)
- USB-C charging cable and durable carrying case

264 POUNDS

Item No.	Description	Case Qty	Packaging
75024	Xtreme Pro Series 8" Electric Suction Cup	3	Carton

⚠️WARNING: Cancer and Reproductive Harm- www.P65Warnings.ca.gov. See P. 67, *Prop 65 - 1.



SCAN HERE FOR PRODUCT VIDEO

8" Pump Suction Cup with Gauge



- Hand held, portable tool for lifting large tiles, stone, glass, and more
- Red line indicator shows when to engage suction
- Safety gauge to monitor suction
- Anti-slip sealed safety rim

285 POUNDS

Item No.	Description	Case Qty	Packaging
75022	8" Pump Suction Cup with Gauge	3	Carton

⚠️WARNING: Cancer and Reproductive Harm- www.P65Warnings.ca.gov. See P. 67, *Prop 65 - 1.



SCAN HERE FOR MORE PRODUCT INFORMATION

8" Vacuum Pump Suction Cup



- Hand held, portable tool for lifting large tiles, stone, glass, and more
- Red line indicator shows when to engage suction
- Sealed safely rim line

242 POUNDS

Item No.	Description	Case Qty	Packaging
75021	8" Vacuum Pump Suction Cup	3	Carton

⚠️WARNING: Cancer and Reproductive Harm- www.P65Warnings.ca.gov. See P. 67, *Prop 65 - 1.



SCAN HERE FOR MORE PRODUCT INFORMATION

X-TREME PRO-SERIES Double Suction Cup

Designed for maneuvering non-porous, smooth tiles, stone, marble, cultured marble, granite and glass during horizontal and vertical applications



- 200 lb. holding capacity is ideal for large format tile
- Rigid, aluminum alloy body with textured, non-slip grip
- Two, 4-3/4" durable rubber pads will not mar tile
- Hold-and-release levers for easy, secure use



Item No.	Description	Case Qty	Packaging
75012	Xtreme Double Suction Cup	3	Shelf Case

⚠WARNING: Cancer and Reproductive Harm- www.P65Warnings.ca.gov. See P. 67, *Prop 65 - 1.



SCAN HERE FOR MORE PRODUCT INFORMATION

ProMAXGrip Double Suction Cup



Item No.	Description	Case Qty	Packaging
75013	ProMAX® Grip Double Suction Cup	3	Shelf Case

- For use on clean, non-porous large format tile, stone and marble
- Dual action suction and release system
- Simple single hand operation
- Strong, textured, non-slip grip

Double Suction Cup



Item No.	Description	Case Qty	Packaging
75003	Double Suction Cup	3	Shelf Case

- Maximum vacuum hold to move smooth, non-porous tile, stone and cultured marble
- Heavy duty, aluminum frame

Suction Cup



Item No.	Description	Case Qty	Packaging
75000	Suction Cup	6	Shelf Case

- For easy handling of non-porous tile, marble and glass during installation
- Suction cup pad is 4-1/2" in diameter
- 3-1/2" wide handle opening easily accommodates large hands

Rubbing Stone



- Dual grit surfaces smooth rough edges on freshly cut ceramic & porcelain tile, stone, marble and brick
- Medium 60-grit on one side and fine 80-grit on the other
- Ideal for dressing diamond blades by exposing fresh diamonds in the blade rim



Item No.	Description	Case Qty	Packaging
10022	Rubbing Stone 6" x 2" x 1"	6	Hang Card

Diamond Sanding Blocks



- Smooth tile, stone, granite, glass, ceramic, and marble
- Manufactured with superior brazed diamond bonding and a lightweight foam base
- Flexible and easy to use in hard to reach places, corners, and edges
- Can be used wet or dry
- Rinse to use again



SUPERIOR BRAZED
DIAMOND BONDING

Item No.	Description	Case Qty	Packaging
10046	60 Grit Sanding Block	6	Hang Card
10047	120 Grit Sanding Block	6	Hang Card
10048	200 Grit Sanding Block	6	Hang Card
10049	400 Grit Sanding Block	6	Hang Card



10046 60 COARSE GRIT 10047 120 MEDIUM GRIT 10048 200 FINE GRIT 10049 400 POLISHING GRIT

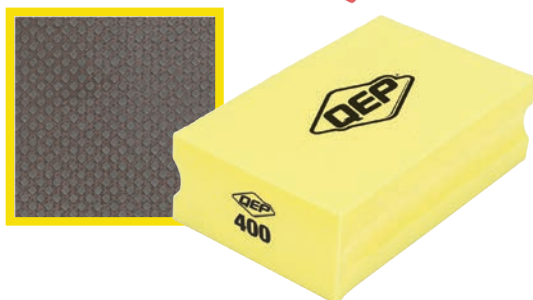

Grit	Purpose
60	Aggressive coarse grit for high rough spots
120	Medium grit for smoothing
200	Fine grit for smoothing
400	Smooth for polishing

Diamond Grit File



- The high quality diamond bond strength maintains a tough grit surface for working with the hardest materials, including ceramic, porcelain, glass and stone
- Can also be used to smooth other materials, including fiberglass, laminate flooring, cement board and carbon fiber
- Flat/round profiles allow for smoothing both straight and curved edges
- Co-molded plastic handle with non-slip, rubber grip for comfortable repeat use



Item No.	Description	Case Qty	Packaging
10586-6	Diamond Grit File	6	Hang Card

Pro Grout Saw



2 BLADES INCLUDED



- Curved heavy duty carbide blades easily remove stubborn grout
- Blade storage in handle can hold up to 2 blades
- Use 1 blade for thinner grout lines and 2 blades for wider grout lines



Item No.	Description	Case Qty	Packaging
10093	Pro Grout Saw	6	Hang Card
75011	Replacement Grout Saw Blades 2 pack	6	Hang Card
QEP Canada Only			
10093C	Pro Grout Saw	6	Hang Card

Grout Saw



2 BLADES INCLUDED

- Strips, cleans and removes old grout, may be used on all grout types
- Includes 1 steel tooth blade for removing tough grout and 1 carbide grit blade for finishing and fine removal
- Use both blades for wide grout lines



Item No.	Description	Case Qty	Packaging
10057	Grout Saw	12	Hang Card
75011	Replacement Grout Saw Blades 2 pack	6	Hang Card
QEP Canada Only			
10057C	Grout Saw	1	Hang Card

Grout Saw Blades



2-Pack

- Replacement blades for the Pro Grout Saw and the Grout Saw 10093, 10093C, 10057, 10057C



Item No.	Description	Case Qty	Packaging
75011	Replacement Grout Saw Blades 2 pack	6	Hang Card

Grout Remover



- For removing unwanted grout, mortar, thinset, calcium, caulking and surface rust
- Double-sided head with 3 durable carbide tips
- Includes 1/16", 1/8" and 3/16" tips for different grout line widths

Item No.	Description	Case Qty	Packaging
10020	Grout Remover	12	Hang Card

Thinset Removal Tool



- For removing excess thinset between tiles, during installation
- Durable, easy to clean plastic material will not scratch tile
- Clearly marked tips for most popular grout joints 1/16", 1/8", 3/16" and 1/4"
- Patent pending 4-in-1 flat, compact tool for easy storage and portability

Item No.	Description	Case Qty	Packaging
62963	Thinset Removal Tool	10	Hang Card
QEP Canada Only			
62963C	Thinset Removal Tool	10	Hang Card

Grout Sealer Applicator



Roller



Brush

- Includes (2) roller wheels for multiple grout widths:
 - Use 1/8" wheel for grout joints 1/8" and smaller
 - Use 1/4" wheel for grout joints 1/4" and larger
- Works with all grout sealers
- Patented roller wheel system provides complete coverage
- Holds 12 oz. (355 ml)

Item No.	Description	Case Qty	Packaging
10279	Grout Sealer Applicator	12	Hang Tab

- Great for small projects with narrow grout joints
- Works with all grout sealers
- Plastic bottle holds up to 4 oz. of grout sealer

Item No.	Description	Case Qty	Packaging
19999	Grout Sealer Brush Applicator	12	Hang Tab

Grout Bag



- Reinforced tip for smooth application and long life
- Protects hands from grout and other harsh substances
- Made of puncture and tear resistant coated vinyl

Item No.	Description	Case Qty	Packaging
76000	Grout Bag	12	Shelf Case

TileTrim Square™

NEW



- Features slots for holding metal trims, and profiles for 45° miter cuts
- V-groove for holding 1/4 rounds allows for a 45° miter cut, resulting in seamless inside and outside corners
- For use with wet saws and chop saws, and various cutting tools
- Works with 95% of tile trim in the market



Item No.	Description	Case Qty	Packaging
10715	TileTrim Square™	6	Shelf Case



SCAN HERE FOR PRODUCT VIDEO

Multi-Use Trim Shears



- Easily cuts quarter round, tile trim, PVC piping, tackstrip and other light materials
- Makes fast angle cuts in wood quarter round, tile trim, PVC piping, tackstrip and other materials
- Eliminates the need for a chop or miter saw
- Miter guide is clearly marked at 45°, 90° and 120°

Item No.	Description	Case Qty	Packaging
10711	Multi-Use Trim Shears	6	Hang Card

Tile Mallet



- Measures 70-75 on the Shore A hardness scale, for a firm hardness with minimum bounce when striking
- Designed for installing both unfinished and prefinished flooring
- Large chamfered mallet head spreads force across the flooring to move it into place during installation
- 16 oz. white rubber head with co-molded plastic 11-1/2" handle with non-slip, rubber grip

Item No.	Description	Case Qty	Packaging
61625	Tile Mallet	3	Hang Handle

White Rubber Mallet

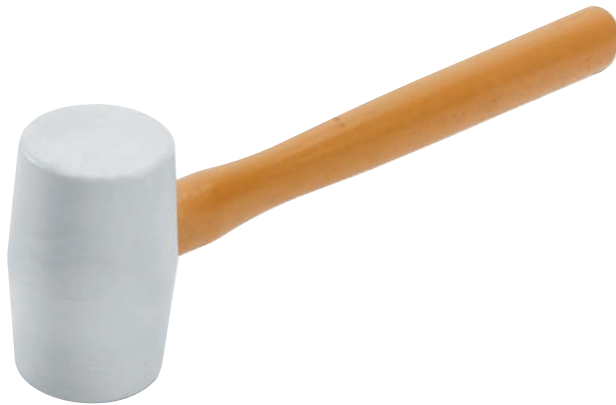

- 16 oz. rubber head securely mounted on hardwood handle
- 12-1/2" in length, 2" diameter rubber head

Item No.	Description	Case Qty	Packaging
61613	White Rubber Mallet	12	Shelf Case

X-TREME[™] BOARD Cement Backer Board

Available as Full Container Orders Only,
Drop Ship Only!



- Zero Fire & Smoke Rating
- Mold, mildew and water resistant
- A better environmental alternative and upgrade to replace gypsum and cement backer board for walls, floors and countertops.
- Contains no silica, no asbestos, no VOC's, no harmful additives
- Contributes to LEED credits and NAHB Green Building Program Credits

Ratings	
R-Value	0.493 / in.
K-Value	2.03 BTU / °F-ft ² -H

Item No.	Description	Pallet Qty	Packaging
73000	Backerboard, 1/4" Thick, 36" x 60"	100	Pallet
73001	Backerboard, 1/4" Thick, 48" x 96"	70	Pallet
73002	Backerboard, 1/2" Thick, 36" x 60"	50	Pallet
73005	Backerboard, 1/8" Thick, 36" x 60"	200	Pallet



SCAN HERE FOR MORE PRODUCT INFORMATION

Folding Backerboard Knife



- Carbide multi-tip design, ideal for puncture and scoring
- Serrated blade base for cutting mesh
- Designed to score all types of backerboards
- Folding design for storage and safe transport
- Strong, lightweight aluminum handle with liner lock



Item No.	Description	Case Qty	Packaging
10072	Folding Backerboard Knife	6	Hang Card

Backerboard Scoring Knife



- Long lasting carbide tips for scoring backerboard
- 2 tips deliver accurate, straight cuts
- Non-slip, rubber grip handle for comfortable repeat use



Item No.	Description	Case Qty	Packaging
10058	Backerboard Scoring Knife	12	Hang Card

Board Seam Tape



- For use in seaming all types of cement backerboard and tile underlayment
- Alkali resistant fiberglass mesh, self-adhesive tape – reduces taping time
- Resists tears and will not shrink

Item No.	Description	Case Qty	Packaging
99600	Board Seam Tape – 2" x 50' roll	24	Shelf Case
99605	Cement Board Seam Tape – 2" x 150' roll	18	Shelf Case

Cleaning Tools

QEP offers all the tools you need for cleanup, including cleaning cloths, sponges and more!
No one sells more tile sponges worldwide!

All-Purpose Heavy Duty Sponge

- Professional, heavy duty sponge for grout clean-up
- Foam density is engineered for quicker grout pick-up and faster rinse
- Perfect for residential, commercial, drywall, auto and marine cleaning



3rd party independent laboratory testing shows that the QEP Sponge outperforms other brands in Elongation, Tensile and Tear Strength

Rounded Corner - 7.5" x 5.5" x 1.875"			
Item No.	Description	Case Qty	Packaging
70005-24	All-Purpose Heavy Duty Sponge, Individually bagged	24	Shelf Case
70005Q-6D	All-Purpose Heavy Duty Sponge, Value 6 Pack	24	Shelf Case
70005-750	All-Purpose Heavy Duty Sponge, Bulk Bale	750	Bale
70005D	All-Purpose Heavy Duty Single Pack Sponge Display	252	Floor Display
70005-3VPD	All-Purpose Heavy Duty 3 Pack Sponge	84	Floor Display

QEP Canada Only			
Item No.	Description	Case Qty	Packaging
70005	XL All-Purpose Sponge, Bulk Bale	600	Bale
70005C-24	XL All-Purpose Sponge, Individually bagged	36	Shelf Case

Square Corner - 6.75" x 4.625" x 2.375"			
Item No.	Description	Case Qty	Packaging
70006-18	Pro Square Grouting Sponge, Individually bagged	18	Shelf Case

Scrubbing Sponge



- Designed for removing wet and drying grout during floor and wall tile installation
- Premium density, heavy duty sponge on one side and scrubbing pad on the other for all in one cleaning
- Hydrophilic design for high water holding capacity and scrub pad removes tough stains
- Rounded corner design prevents digging out or marring grout
- Perfect for residential, commercial, office, car, boat and RV cleaning
- 7-1/2" x 5-1/4" x 1-7/8"

Item No.	Description	Case Qty	Packaging
70007-24	Scrubbing Sponge, Individually bagged	24	Shelf Case
QEP Canada Only			
70007C-24	Scrubbing Sponge, Individually bagged - Only available in Canada	24	Shelf Case

Microfiber Polishing Sponge



- Microfiber side ideal for cleaning grout, applying sealer and polishing tile
- Rounded corners prevent digging out or marring of grout joints
- For use on sanded and non-sanded grouts
- 7-1/2" x 5-1/2" x 2"
- Great for washing and polishing cars, boats, countertops and furniture

Item No.	Description	Case Qty	Packaging
70010	Microfiber Polishing Sponge	24	Shelf Case
QEP Canada Only			
70010C-24	Microfiber Polishing Sponge - Only available in Canada	24	Shelf Case

Microfiber Grout Cleaning Cloth



- Oversized, microfiber cloth for removing grout haze, as well as general dusting, washing and cleaning
- Soft, yet durable and heavy weight material is great for wet or dry use
- 100% microfiber cloth, including double sided edge stitching
- Machine washable, and great for general purpose cleaning on most home surfaces, including cars and boats

Item No.	Description	Case Qty	Packaging
70018	Microfiber Grout Cleaning Cloth 18" x 18"	12	Hang Card

Microfiber Surface Cleaning Cloth



2-Pack



- High absorbency cloth absorbs up to 5x its weight in water
- Soft microfiber on one side, non-abrasive scrubbing micro-bristles on the other
- Rows of micro-bristles safely scrub away dried grout and tough to remove dirt and grime
- Machine washable

Item No.	Description	Case Qty	Packaging
70019	Microfiber Surface Cleaning Cloth 14" x 14" 2-Pack	12	Hang Card

Polishing Cheesecloth



- For removing grout haze after installation
- 5 square yards (36" x 180")
- Great for polishing most tile surfaces to a bright shiny finish
- 100% cotton, professional grade fine mesh

Item No.	Description	Case Qty	Packaging
76030	Polishing Cheesecloth	12	Hang Card

Heavy Duty Plastic Mixing Bucket

NEW



- Heavy duty 5-gallon bucket with lifting capacity up to 84 lbs
- Reinforced ring design allows several buckets to nest and separate easily
- Sturdy wire bail with a plastic handgrip for easy lifting
- Versatile for job sites, gardening and general use

Item No.	Description	Case Qty	Packaging
78105	QEP Heavy Duty 5 Gallon Plastic Mixing Bucket - White	1	Open Stock

Large Handle Scrub Brush



Handle Sold Separately



- Features corner brush head design
- Stiff nylon V cut bristles for cleaning deep into grout
- Built in scraper for tough dirt and grime
- Swivel head pole attachment allows for use standing up and provides additional leverage

Item No.	Description	Case Qty	Packaging
20839	Large Handle Scrub Brush	8	Hang Card

Grout Cleaning Brush



- Multi-purpose cleaning brush with outstanding performance on tile and grout
- Ergonomic handle includes thumb rest for leverage and comfort
- Durable, angled nylon bristles remove grime in creases

Item No.	Description	Case Qty	Packaging
20842	Grout Cleaning Brush	12	Hang Card
QEP Canada Only			
20842C	Grout Cleaning Brush	12	Hang Card

Heavy Duty Multipurpose Gloves



- Chemical resistant - protects hands from the corrosive action of grout, chemicals and other harsh substances
- 100% heavy duty latex is puncture and tear resistant
- One size fits most
- Non-slip ribbing on thumb and finger surfaces



Item No.	Description	Case Qty	Packaging
21591	Heavy Duty Multipurpose Gloves	24	Shelf Case

SureGrip Tiler's Gloves



2-Pack

- Provides excellent grip and dexterity when handling tile and stone
- Patented SureGrip® technology provides an over 400% better grip in wet conditions and 60% better grip in dry conditions compared to standard latex and nitrile material
- Durable, lightweight mesh fabric with elastic wrist band to keep gloves in place
- Touchscreen compatible for easy smartphone and tablet use without removing gloves
- 2 pair of gloves per set
- One size fits most

Item No.	Description	Case Qty	Packaging
21595	SureGrip® Tiler's Gloves (2 pairs of gloves)	10	Shelf Case

Floor & Wall Tile Installation Kit

**SAVE
14%**



- Complete kit containing all the tools necessary to install ceramic tile on floors
- Kit contains:
 - Double-sided trowel: 3/16" X 5/32" V notch
 - 1/4" X 1/4" X 1/4" Square notch
 - Comfort Grip 6" x 2" Margin Float
 - Sponge
 - Tear resistant, reinforced grip multipurpose gloves
 - Washable kneepads
 - Reusable 2.5 gallon plastic bucket

Item No.	Description	Case Qty	Packaging
78251	Floor & Wall Tile Installation Kit	1	Shelf Case

Tile Installation Kit

**SAVE
15%**



- Complete kit containing all the tools necessary to install ceramic tile on floors
- Kit contains:
 - Molded rubber float
 - 1/4" x 3/8" x 1/4" square notch floor trowel
 - 8" tile nippers, sponge, disposable gloves
 - Reusable 2.5 gallon plastic bucket
 - Complete installation instructions

Item No.	Description	Case Qty	Packaging
78220Q	Tile Installation Kit	1	Shelf Case
QEP Canada Only			
78220QC	Tile Installation Kit	1	Shelf Case

Toilet Installation Kit & Accessories

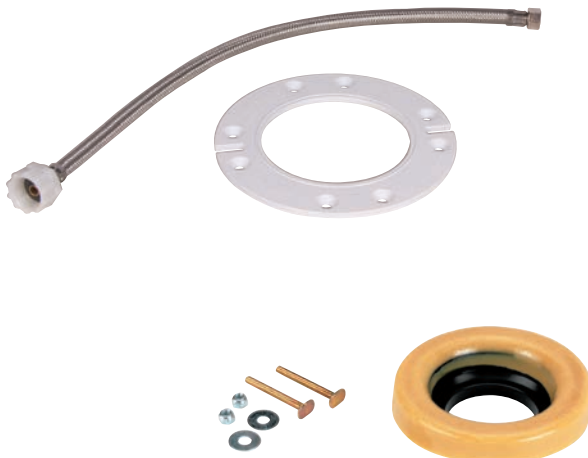

- Includes: WM Harvey No-Seep® No. 50 Extra Thick Wax Gasket with Polyethylene Flange, Fluidmaster® 12" SS Braided Toilet Connector, Bolt Kit - 1/4" x 2-1/4" brass-plated closet bolts with nuts and washers

Item No.	Description	Case Qty	Packaging
38229	Toilet Installation Kit with 12" Connector	1	Shelf Case



Ashlee Dudding, QEP
Digital Content Specialist,
demonstrating the QEP 10800
28" Big Clinker tile cutter.

TILE CUTTERS & SCORING WHEELS

QEP offers professional cutters for cutting tile, porcelain, mosaics and other materials. The QEP lightweight Slimline cutters, multipurpose Big Clinkers and traditional cutters are engineered for the Pros by the Pros. Designed to make cutting easy with features like side arm extensions, ball bearing slides and locking features, QEP puts quality and safety first.

24", 30" and 36" Slimline Cutters

ENGINEERED FOR THE PROS BY THE PROS



Only 5-1/2" wide and lighter than standard cutters



SLIMLINE

- Lightweight and easy to carry from site to site
- Equipped with replaceable tungsten-carbide 7/8" scoring wheel
- Reinforced thick steel base with tile support arms
- Die cast aluminum rail supports
- Metal rip guide



Item No.	Description	Case Qty	Packaging
10624Q	24" Slimline Manual Tile Cutter, with 2 legs	1	Color Carton
10636Q	36" Slimline Manual Tile Cutter, with 4 legs	1	Color Carton
QEP Canada Only			
10632Q	30" Slimline Manual Tile Cutter, with 2 legs	1	Color Carton

REPLACEMENT SCORING WHEEL:
 21178 7/8" Titanium-Coated Tungsten Carbide Scoring Wheel (3/cs)



RIP CUT
 10624Q: Up to 24" Tile
 10632Q: Up to 30" Tile
 10636Q: Up to 36" Tile



DIAGONAL
 10624Q: Up to 18" Tile
 10632Q: Up to 21" Tile
 10636Q: Up to 25" Tile



TILE DEPTH
 1/2" Max.

SCAN HERE FOR MORE PRODUCT INFORMATION



28", 25" & 22-1/2" Big Clinker Tile Cutter

Multipurpose cutter for most tile including ceramic and porcelain



- Height adjustable 4-position wheel for easy snapping in any position on tile
- Equipped with replaceable 7/8" titanium-coated tungsten carbide ball bearing scoring wheel
- Side arm extensions to support large format tiles
- Durable chrome plated steel rails
- Rip/Angle guide for fast multiple cuts
- Heavy duty cast aluminum base



Item No.	Description	Case Qty	Packaging
10800	28" Big Clinker Tile Cutter	1	Color Carton
10600	25" Big Clinker Tile Cutter	1	Color Carton
10500	22-1/2" Big Clinker Tile Cutter	1	Color Carton



REPLACEMENT SCORING WHEEL:
 211230 7/8" PREMIUM Titanium-Coated Tungsten Carbide Ball Bearing Scoring Wheel (6/cs)



RIP CUT
 10800: Up to 28" Tile
 10600: Up to 25" Tile
 10500: Up to 22.5" Tile



DIAGONAL
 10800: Up to 20" Tile
 10600: Up to 18" Tile
 10500: Up to 16" Tile



TILE DEPTH
 10800: 1/2" Max.
 10600: 5/8" Max.
 10500: 1/2" Max.



10600



10800



10500

SCAN HERE FOR MORE PRODUCT INFORMATION

48" LFT Manual Tile Cutter

Cuts porcelain, floor tile, mosaics, and other materials

- Ball bearing cutting head for accurate and easy scoring
- Breaking System Lever produces max amount of pressure
- Locking slide to prevent damage in transport
- Locking swivel angle and measurement bar
- Dual breaker bar for narrow and wide tile
- Equipped with replaceable tungsten-carbide 7/8" scoring wheel
- Breaking pads are mounted on springs for better shock absorption
- Cut-out under breaking pads allows for tile cuttings to fall through for easy cleaning



Item No.	Description	Case Qty	Packaging
10480Q	48" LFT Manual Cutter	1	Color Carton

REPLACEMENT SCORING WHEEL:
21178 7/8" Titanium-Coated Tungsten Carbide Scoring Wheel (3/cs)



RIP CUT
10480Q: Up to 48" Tile



DIAGONAL
10480Q: Up to 34" Tile



TILE DEPTH
5/8" Max.



SCAN HERE FOR MORE PRODUCT INFORMATION

35" & 24" Pro Tile Cutters

Multipurpose cutter for most tile including ceramic and porcelain

- Ball bearing slide for smooth scoring
- Side arm extensions to support large format tiles
- Equipped with replaceable 7/8" titanium-coated tungsten carbide ball bearing scoring wheel
- Durable chrome plated steel rails
- Rip/Angle guide for fast multiple cuts



Item No.	Description	Case Qty	Packaging
10900	35" Pro Tile Cutter	2	Color Carton
10630	24" Pro Tile Cutter	1	Color Carton

REPLACEMENT SCORING WHEEL:
21125 7/8" Titanium-Coated Tungsten Carbide Ball Bearing Scoring Wheel (6/cs)



RIP CUT
10900: Up to 35" Tile
10630: Up to 24" Tile



DIAGONAL
10900: Up to 24" Tile
10630: Up to 17.5" Tile



TILE DEPTH
1/2" Max.



SCAN HERE FOR MORE PRODUCT INFORMATION

21" Pro Tile Cutter

Cuts ceramic and porcelain tile

- High leverage, padded handle makes cutting easier and reduces fatigue
- Durable chrome-plated solid steel rails for smooth scoring
- Includes replaceable tungsten carbide 10 mm post scoring wheel
- Powder coated steel base with extra reinforcement



RIP CUT
10221Q: Up to 21" Tile



DIAGONAL
10221Q: Up to 15" Tile



TILE DEPTH
3/8" Max.

Item No.	Description	Case Qty	Packaging
10221Q	21" Pro Tile Cutter	2	Color Carton

20" & 14" Pro Tile Cutter

Cuts ceramic and porcelain tile

- Equipped with replaceable 1/2" titanium-coated tungsten carbide scoring wheel
- Reinforced steel base



REPLACEMENT SCORING WHEEL:
10010HD 1/2" Tungsten Carbide Scoring Wheel
(12/cs)



RIP CUT
10220Q: Up to 20" Tile
10214Q: Up to 14" Tile



DIAGONAL
10220Q: Up to 14" Tile
10214Q: Up to 10" Tile



TILE DEPTH
3/8" Max.

Item No.	Description	Case Qty	Packaging
10220Q	20" Pro Tile Cutter	4	Color Carton
10214Q	14" Pro Tile Cutter	6	Color Carton

Replacement Wheels for Tile Cutters

ITEM NO.	DESCRIPTION	21127Q 10 mm Wheel	10010HD 1/2" Wheel	21123Q 7/8" Wheel	21125 7/8" Wheel	21178 7/8" Wheel
10480Q	48" LFT Manual Tile Cutter					•
10636Q	36" Slimline Tile Cutter					•
10632Q	30" Slimline Tile Cutter					•
10624Q	24" Slimline Cutter					•
10900	35" Tile Cutter				•	
10800	28" Big Clinker Tile Cutter			•		
10630	24" Tile Cutter				•	
10600	24" Big Clinker Tile Cutter			•		
10221Q	21" Pro Tile Cutter	•				
10500	22-1/2" Big Clinker Tile Cutter			•		
10220Q	20" QEP Tile Cutter		•			
10214Q	14" QEP Tile Cutter		•			

10 mm Post Scoring Wheel



- For cutting ceramic, porcelain and glass tiles
- Tungsten carbide scoring edge for long cutting life
- For use with 10221Q 21" Professional Tile Cutter

Item No.	Description	Case Qty	Packaging
21127Q	10 mm Post Scoring Wheel	6	Hang Card

1/2" Tungsten Carbide Scoring Wheel

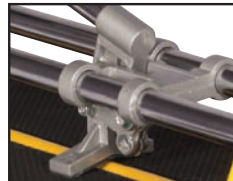

- For cutting ceramic, porcelain and glass tiles
- For use with 10220Q 20" QEP Tile Cutter and 10214Q 14" QEP Tile Cutter

Item No.	Description	Case Qty	Packaging
10010HD	1/2" Tungsten Carbide Scoring Wheel	12	Hang Card

7/8" Replacement Scoring Wheels with Ball Bearings

- For cutting ceramic, porcelain and glass tiles • Ball bearing wheel for smooth scoring • Designed to use with any tile cutters



- **For use with:**
10800 28" Big Clinker Tile Cutter
10600 24" Big Clinker Tile Cutter
10500 22-1/2" Big Clinker Tile Cutter

- **For use with:**
10900 35" Tile Cutter
10603 24" Tile Cutter

- **For use with:**
10480Q LFT Manual Tile Cutter
10636Q 36" Slimline Tile Cutter
10632Q 30" Slimline Tile Cutter
10624Q 24" Slimline Tile Cutter

Item No.	Description	Case Qty	Packaging
21123Q	7/8" Premium Tile Cutter Replacement Scoring Wheel with Ball Bearings	6	Hang Card

Item No.	Description	Case Qty	Packaging
21125	7/8" Tile Cutter Replacement Scoring Wheel with Ball Bearings	6	Hang Card

Item No.	Description	Case Qty	Packaging
21178	7/8" Titanium Coated Replacement Scoring Wheel for Multiple Tile Types	3	Hang Card

Working Bench

AVAILABLE
FALL 2024

Lightweight and stable workbench for large-format tiles, enabling cutting / drilling without risk of damaging the work surface



- Easy fold up and transport
- Maximum load 441 lbs (200 Kg)
- Top rubber caps keep tile off surface when drilling or cutting
- Table is 32" H x 55" W x 70" L

441
POUNDS

Item No.	Description	Case Qty	Packaging
75027	Working Bench	1	Color Carton

Carrier System

AVAILABLE
FALL 2024

Lightweight carrying system with six suction cups for easy transport of large format tile



- Suitable to carry tile size up to 10-1/2" x 5'
- Maximum load 1716 lbs (778 Kg)
- Includes 6 vacuum suction cup with brass handle
- Each suction cup holds 286 lbs (130 kg)
- Featured with four soft grip handles on the top and four extension handle on the side for extra support

1716
POUNDS

Item No.	Description	Case Qty	Packaging
75028	Carrier System	1	Color Carton

45° Angle Cutting System

AVAILABLE
FALL 2024



- Provides perfect 45° angles
- Cutting Span up to 19 mm thickness
- Diamond Blade dust collector

Item No.	Description	Case Qty	Packaging
75030	45° Angle Cutting System	1	Color Carton

Transport Cart

AVAILABLE
FALL 2024



- Perfect solution for moving large format tiles
- 32" width fits through doors
- Max load 617 lbs
- Lockable non marring rubber castors provide stability and flexibility



Item No.	Description	Case Qty	Packaging
75029	Transport Cart	1	Color Carton

Vibrating Suction Cup

AVAILABLE
FALL 2024



- Variable speed vibration
- Eliminates trapped air bubbles under tile
- Can be used on floor and wall tile
- Suction cup lifting power up to 77 lbs
- Lithium Battery



Item No.	Description	Case Qty	Packaging
75031	Vibrating Suction Cup	1	Color Carton

Vibration Enhancer Block

AVAILABLE
FALL 2024



- Works with most suction cups to spread vibration
- Size - 10" X 7" X 1/2"

Item No.	Description	Case Qty	Packaging
75032	Vibration Enhancer Block	1	Color Carton



Rodrigo Vera, QEP President of Specialty Markets, cuts tile with the QEP 61900Q 900XT 2.25 HP wet tile saw.

TILE SAWS & DIAMOND BLADES

QEP's line of award-winning Tile Saws for cutting large format ceramic, porcelain, granite, stone and marble tile are engineered by the pros for the pros. Designed with features such as splash guard water containment systems, extension tables and safety locks, QEP Tile Saws make work easier. Our Diamond Blade line assures smooth and precise cuts every time.

10" 900XT Pro Wet Tile Saw

Portable electric wet tile saw with fold-out stand for cutting large format tile including ceramic, porcelain, granite, and marble

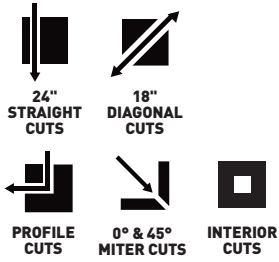

24"
STRAIGHT
CUTS

18"
DIAGONAL
CUTS



PROFILE
CUTS



0° & 45°
MITER CUTS



INTERIOR
CUTS



- Heavy duty 2.25 HP, 15 Amp motor
- Adjustable plunging and pivoting motor head for interior cutting, miter cuts and rip/angle cuts
- Full coverage splash guard water containment system
- Side extension table
- Laser cutting guide & LED work area light

*Complies with Canadian and U.S. requirements

ACCESSORIES INCLUDED

- Premium porcelain rated 10" blade
- Rip/Angle cutting guide
- Quick release folding stand with oversized wheels
- 2 wrenches

Item No.	Description	Case Qty	Packaging
61900Q	10" 900XT Pro Wet Tile Saw	1	Color Carton



SPECIFICATIONS

Item No	61900Q
Motor	2.25 HP / 120V-60 Hz. / 15 Amps
Watts	1750
RPM	3600
Blade Capacity	10"
Arbor	5/8"
Size	51" L x 33" W x 45" H (w/stand)
Weight	96 lbs (w/stand)

*For porcelain and hard tiles, we recommend QEP's Black Widow® (6-1008BW)



SCAN HERE FOR MORE PRODUCT INFORMATION

7" Power Pro 1HP Wet Tile Saw

Portable electric cutter for cutting porcelain tile, ceramic tile, marble, slate and stone



- Powerful 1 HP 3600 RPM direct drive motor
- Interior water baffle minimize water-spray and reduces refills
- Oversized die cast aluminum table
- Non-slip feet and fold-out bench stop keep saw in place during use
- Locking on/off switch with security key
- Tested and Compliant - Exceeds OSHA Silica Rule 29 CFR 1926.1153

*Complies with Canadian and U.S. requirements

ACCESSORIES INCLUDED

- 7" continuous rim wet diamond blade
- Locking rip guide
- Angle cutting guide
- Bench stop



SPECIFICATIONS

Item No	22900Q
Motor	1 HP / 120 V ~ 60 Hz. / 6.5 Amps
Watts	750
RPM	3600
Blade Capacity	7"
Arbor	5/8"
Size	22.5" L x 18" W x 8" H
Weight	29 lbs

Item No.	Description	Case Qty	Packaging
22900Q	7" Power Pro 1HP Wet Tile Saw	1	Color Carton

*For porcelain and hard tiles, we recommend QEP's Black Widow® (#6-7008BW)



SCAN HERE FOR MORE PRODUCT INFORMATION

7" 750XT Wet Tile Saw

Portable electric cutter for cutting porcelain tile, ceramic tile, marble, slate and stone

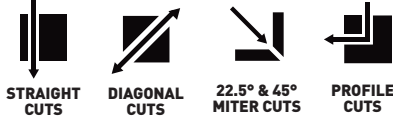

- Powerful 3/4 Peak HP motor
- Locking adjustable angle and rip guides for accurate cuts
- Interior water baffle minimize water-spray and reduces refills
- Unique back extension table to support large format tile during cut
- Tested and Compliant - Exceeds OSHA Silica Rule 29 CFR 1926.1153

*Complies with Canadian and U.S. requirements

ACCESSORIES INCLUDED

- 7" continuous rim wet diamond blade
- 45° angle guide
- Blade guard



SPECIFICATIONS

Item No	22750Q
Motor	3/4-Peak HP/120 V~ 60 Hz. / 4.8 Amps
Watts	550
RPM	3600
Blade Capacity	7"
Arbor	5/8"
Size	21" L x 22.2" W x 9.5" H
Weight	21.4 lbs

Item No.	Description	Case Qty	Packaging
22750Q	7" 750XT Wet Tile Saw	1	Color Carton

*For porcelain and hard tiles, we recommend QEP's Black Widow® (6-7008BW)



SCAN HERE FOR MORE PRODUCT INFORMATION

7" 700XT Wet Tile Saw

Portable electric wet saw for cutting ceramic, slate, marble, granite and porcelain

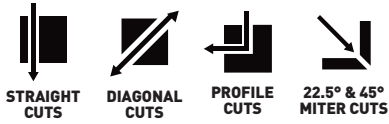

- Powerful 3/4 Peak HP motor
- Lock-down rip guide for fast, multiple cuts
- Extension side table
- Deep water tray means no refilling
- Water recirculation channel

*Complies with Canadian and U.S. requirements

ACCESSORIES INCLUDED

- 7" continuous rim wet diamond blade
- Blade wrench



SPECIFICATIONS

Item No	22700Q
Motor	3/4-Peak HP/120V ~ 60 Hz. / 4.8 Amps
Watts	550
RPM	3600
Blade Capacity	7"
Arbor	5/8"
Size	20.08" L x 15.74" W x 9.88" H
Weight	23 lbs

*For porcelain and hard tiles, we recommend QEP's Black Widow® (6-7008BW)



Item No.	Description	Case Qty	Packaging
22700Q	7" 700XT Tile Wet Saw	1	Color Carton



SCAN HERE FOR MORE PRODUCT INFORMATION

4" Torque Master XT Portable Wet Tile Saw

Portable electric cutter for cutting porcelain tile, ceramic tile, marble, slate and stone



- 3/5 HP, hi-torque geared motor for maximum cutting performance
- Fully adjustable miter guide with unique ratchet mechanism
- Water recirculation system saves time when replenishing water supply and keep work area drier
- Dual extension tables add extra 5" of cutting surface

*Complies with Canadian and U.S. requirements

ACCESSORIES INCLUDED

- 4" continuous rim diamond blade (#6-4003Q)
- 45° angle guide
- Blade guard



SPECIFICATIONS

Item No	22400Q
Motor	3/5-Peak HP / 120 V ~ 60 Hz. / 4 Amps
Watts	450
RPM	4600
Blade Capacity	4"
Arbor	5/8"
Size	14.3" L x 15.8" W x 4.6" H
Weight	8 lbs

Item No.	Description	Case Qty	Packaging
22400Q	4" Torque Master XT Portable Wet Tile Saw	1	Color Carton

*For porcelain and hard tiles, we recommend QEP's Black Widow® (6-4008BW)



SCAN HERE FOR MORE PRODUCT INFORMATION



Tile Saws at a glance

Professional Wet Saw

ITEM NO.	DESCRIPTION	WEIGHT (lbs)	BLADE	HP	RPM	RIP CUT (Tile Size)	DIAGONAL (Tile Size)	CUTTING DEPTH
61900Q	10" 900XT Pro Wet Tile Saw	96	10"	2-1/4	3600	24"	18"	3-3/4"

Professional Table Saws

ITEM NO.	DESCRIPTION	WEIGHT (lbs)	BLADE	HP	RPM	RIP CUT (Tile Size)	DIAGONAL (Tile Size)	CUTTING DEPTH
22900Q	7" Power Pro Wet Tile Saw	29	7"	1	3600	Unlimited	Unlimited	1-1/8"
22750Q	7" 750XT Wet Tile Saw	21.4	7"	3/4	3600	Unlimited	Unlimited	1-1/4"
22700Q	7" 700XT Wet Tile Saw	23	7"	3/4	3600	Unlimited	Unlimited	1-1/4"
22400Q	4" Torque Master XT Portable Tile Saw	8	4"	3/5	4600	Unlimited	Unlimited	1/4"

Black Widow® Blades

The QEP Black Widow® Premium-Grade, thin-rim Diamond Blades quickly cut through the toughest ceramic, porcelain, marble and granite. Independent lab test results have proven Black Widow® Blades continuously out perform the competition in durability. QEP blades are designed to use with any tile saws.



- Premium-grade, thin-rim diamond blade for fast wet cutting of porcelain, ceramic, granite and marble tile
- Ideal for high speed cutting of hard masonry tile
- Unique diamond-shaped laser cutouts prevent blade wobble and keep blade cooler for a longer life
- 7 mm rim height for a longer life and for increased cutting contact with the blade



Item No.	Description	Application	Rim Height	Width	Arbor Size	Max RPM	No. in Case	Package
6-4008BW	4" Black Widow®	Ceramic, Porcelain, Marble, Granite - Wet/Dry	7 mm	.060	5/8" - 20 mm - 7/8"	15000	5	Hang Card
6-7008BW	7" Black Widow®	Ceramic, Porcelain, Marble, Granite - Wet	7 mm	.060	5/8"	8730	5	Hang Card
6-8008BW	8" Black Widow®	Ceramic, Porcelain, Marble, Granite - Wet	7 mm	.060	5/8"	7640	5	Hang Card
6-1008BW	10" Black Widow®	Ceramic, Porcelain, Marble, Granite - Wet	7 mm	.060	5/8"	6115	5	Hang Card

⚠ WARNING: Cancer and Reproductive Harm - www.P65Warnings.ca.gov. See P. 67, *Prop 65 - 1.

Diamond Blades

The QEP diamond blade line offers a blade for every application and budget. Whether your tile project requires the cutting of ceramic, porcelain, marble, granite, glass, slate, concrete pavers or stone, QEP has a blade that will cut it quickly and efficiently. QEP blades are designed to use with any tile saws.



Black Series General purpose blade for wet cutting of ceramic tile.

Item No.	Description	Rim Height	Width	Arbor Size	Max RPM	No. in Case	Package
6-4001Q	4" Continuous Rim	7 mm	.060	5/8" - 20 mm - 7/8"	15000	4	Hang Card
6-7001Q	7" Continuous Rim	7 mm	.060	5/8" - DM	8730	4	Hang Card
6-8001Q	8" Continuous Rim	7 mm	.060	5/8" - DM	7640	4	Hang Card
6-1001Q	10" Continuous Rim	7 mm	.060	5/8" - DM	6115	4	Hang Card



Gold Series Premium blade for wet or dry* cutting of ceramic, porcelain and marble tile.

Item No.	Description	Rim Height	Width	Arbor Size	Max RPM	No. in Case	Package
6-4003Q	4" Continuous Rim	7 mm	.060	5/8" - 20 mm - 7/8"	15000	4	Hang Card
6-7003Q	7" Continuous Rim	7 mm	.060	5/8"	8730	4	Hang Card
6-8003Q	8" Continuous Rim	7 mm	.060	5/8"	7640	4	Hang Card
6-1003Q	10" Continuous Rim	7 mm	.060	5/8"	6115	4	Hang Card

*4" can be used for wet/dry cutting, other sizes are for wet cutting only.



Glass Series Premium blade for wet cutting of glass tile.

Item No.	Description	Rim Height	Width	Arbor Size	Max RPM	No. in Case	Package
6-4006GLQ	4" Continuous Rim	7 mm	.060	5/8" - 20 mm - 7/8"	15000	3	Hang Card
6-7007GL	7" Continuous Rim	7 mm	.060	5/8"	8730	3	Hang Card

⚠ WARNING: Cancer and Reproductive Harm - www.P65Warnings.ca.gov. See P. 67, *Prop 65 - 1.

POWERFUL ADJUSTABLE VERSATILE

W S O E R P



**10-56
LONGNECK PLUS
6" JAMB SAW**



**10-46
SUPER SIX
6" JAMB SAW**

ROBERTS® Super Six and Longneck Plus 6" Jamb Saws are powerful and versatile tools that meet a wide variety of undercutting needs. From doorjamb and molding to under toekicks and undercut doors, we're ready for all of your flooring installation needs. Featuring adjustable cutting depth guides (to prevent cutting into plaster or wallboards) and precision height specifications (allowing cuts from flush to 1-1/16" above the floor) our ROBERTS Jamb Saws help get the job done right every time.

Supporting Professional Installers Since 1938



robertsconsolidated.com

866.435.8665

Scan here for
PRODUCT
INFORMATION

10-46 Super Six
6" Jamb Saw



10-56 Longneck Plus
6" Jamb Saw





TEAR-OUT TOOLS

When starting a new project, QEP knows scrapers and chisels need to be strong and durable to get the job done. We offer smaller handheld options, chisels and scrapers that can accommodate handles for extended reach and traditional demolition, surface and floor scrapers. All of these tools are designed for better leverage, comfort and control while working.

14" Surface Scraper

NEW

- Flexible 14" blade helps remove old floors and cleans up excess debris
- Great for removing vinyl, carpet glue, plaster and popcorn ceilings
- 5' long handle and flex blade made of premium quality carbon steel offer long-lasting durability



Item No.	Description	Case Qty	Packaging
20900Q	14" Surface Scraper	6	Hang Card
21000Q	14" Replacement Blade	3	Hang Card
QEP Canada Only			
20902C	14" Surface Scraper	6	Hang Card

7" Heavy Duty Floor Scraper

NEW

- Thick, professional high-carbon steel 7" blade scrapes up concrete, marble, ceramic tile and wood floors
- All welded construction made of pipe steel with a replaceable rigid blade
- Rips up roofing and vinyl flooring; Chips away cement and plaster
- 4' long handle includes foot peg for better leverage on difficult projects
- Also great for ice removal



Item No.	Description	Case Qty	Packaging
75006Q	7" Heavy-Duty Floor Scraper	6	Hang Card
75007Q	7" Replacement Blade	3	Hang Card
QEP Canada Only			
75017C	7" Heavy-Duty Floor Scraper	6	Hang Card

Demolition Scraper

NEW



- Unique reversible hardened steel blade can easily be converted from 5" to 3" wide (ideal for scraping in tight areas)
- Double angled design offers increased leverage during scraping and prying
- Great for removing tile, wood, laminate, stone, carpet, ice and roofing
- Resharpenable hard steel (use file or grinder)
- Galvanized steel ergonomic handle reduces fatigue

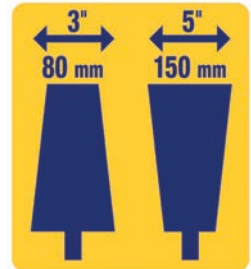

Item No.	Description	Case Qty	Packaging
62965Q	Demolition Scraper	3	Hang Card

8" Adjustable Razor Floor Scraper

NEW



- Twist lock adjustable telescoping handle adjusts from 3' to 6' in length
- Removes old adhesive, vinyl, carpet and other floor covering materials
- Deluxe cushioned grip handle provides added comfort
- 15° angled 8" blade head for ease of comfort when scraping



Includes canvas cover



Item No.	Description	Case Qty	Packaging
62909Q	8" Adjustable Razor Floor Stripper	6	Hang Card
Replacement Blades			
62904Q	8" Stripper Blades (3 on a skincard)	10	Hang Card
62907Q	8" Stripper Blades (10 on a skincard)	1	Hang Card
QEP Canada Only			
62909QC	8" Adjustable Razor Floor Stripper	6	Hang Card

4" Razor Scraper



- Handle features internal blade storage and built-in screwdriver for easy accessibility
- Attach handle to a threaded pole for an extended reach
- Metal hammer end for use on stubborn material
- Includes five 4" stainless steel blades
- Co-molded plastic handle core with non-slip, rubber grip

Item No.	Description	Case Qty	Packaging
62920	4" Razor Scraper	6	Hang Card
QEP Canada Only			
62920C	4" Razor Scraper	6	Hang Card
Replacement Blades			
62901	4" Razor Scraper Blades (5 on a skincard)	6	Hang Card

Xtreme Pro-Series Heavy Duty Chisel Scraper

For splitting and breaking concrete, brick and more



- Features over strike impact guard
- Industrial grade with rust preventative coating
- Precision ground cutting edge
- Shock-absorb handle features non-slip grip for added control

Item No.	Description	Case Qty	Packaging
62971	Xtreme Heavy Duty Chisel	4	Hang Card



SCAN HERE FOR MORE PRODUCT INFORMATION

Chisel Scraper



- Heavy duty 3 in. stainless steel blade
- Attach handle to a threaded pole for an extended reach
- End of handle features a rubber mallet plate for stubborn material
- Co-molded plastic handle core with non-slip, rubber grip

Item No.	Description	Case Qty	Packaging
62972	Chisel Scraper	6	Hang Card
QEP Canada Only			
62972C	Chisel Scraper	6	Hang Card



KNEE PADS

Offering installers several designs for knee protection, QEP prioritizes your time and safety. From EVA foam and memory foam to encapsulated gel layers, we've got you covered. Most QEP kneepads also offer convenient side loops for pen storage to quickly make marks.

ProMAXGel Knee Pads

- Gel layer is fully encapsulated in EVA foam to prevent delamination and minimize wear
- Textured cap surface for a non-slip grip and moisture-wicking neoprene liner for comfort
- Micro hook and loop fastening technology down the length of the strap for a perfect fit
- Convenient side pen loops for pen storage

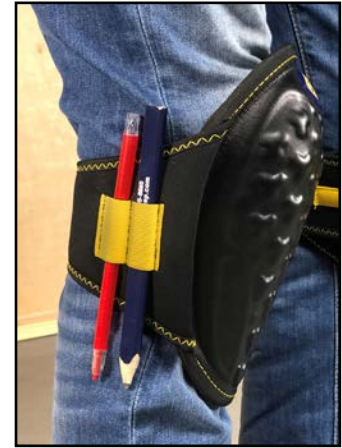

Item No.	Description	Case Qty	Packaging
79645	ProMAX® Gel Knee Pads	6	Hang Card Shelf Case
79645D	ProMAX® Gel Knee Pad Display	20 pair per display	Floor Display see page 67

Comfort Grip Knee Pads

- Comfortable EVA form-fitting foam padding for cushioning
- Soft neoprene inner lining will not adsorb sweat so the knee pads won't develop an odor
- Stretching, neoprene strap with adjustable hook and loop fasteners hold the knee pads in place
- Convenient side pen loops for pen storage



Item No.	Description	Case Qty	Packaging
79634	Comfort Grip Knee Pads	8	Hang Card Shelf Case

STABILIZER FORMS FITS FLEXES Professional Knee Pads

Comfort Wrap Technology *with Memory Foam*



- Memory foam conforms to your knee shape for a custom fit
- XL Patella Gel Zone and 5 Layer Comfort System provides extended total knee comfort
- Soft Cap Stabilizer for hard or soft surfaces
- Micro hook and loop fastening technology on the entire strap length for a perfect fit
- Convenient side pen loops for pen storage



Item No.	Description	Case Qty	Packaging
79642	F3 Stabilizer Professional Knee Pads	6	Hang Card Shelf Case

Washable Knee Pads



- Compression molded EVA foam for easy washing with a neoprene liner for comfort
- Economical and lightweight for comfort and easy mobility
- Adjustable hook and loop fastening straps hold the knee pads in place



Item No.	Description	Case Qty	Packaging
79640	Washable Knee Pads	14	Hang Card



Kevin Keefe, QEP National Technical Sales Manager and 2022 Regional Finalist for Installer of the Year at the International Surface Event's National Competition, installs QEP Cork Plus Underlayment.

UNDERLAYMENTS & BARRIERS

QEP offers both Aquabar® "B" Moisture Vapor Barrier and cork underlayments to enhance crack suppression. Natural Cork and Cork Plus Underlayments help control sound under ceramic tile and stone and reduce thermal transmissions. Cork Plus is made of natural cork plus recycled EVA foam, making it more flexible.

Benefits of Cork Underlayment



A staple in green building, cork offers superior durability, is impermeable, resistant to mold, mildew, and termites. A natural insulator, cork is fire resistant, and provides unrivaled noise reduction properties.

Our cork sheets and rolls exceed the International Building Code requirements for ambient and impact sound transmission. Cork is an excellent resource for underlayment, and comes from a renewable resource. Cork underlayment is carbon negative and is the exceptional choice.

Using cork underlayment contributes to LEED Green Building Credits.

Cork Plus Sheets and Rolls



- Constructed of 65% natural cork and 35% recycled EVA foam, making it more flexible and less prone to breakage than standard cork underlayment
- Acoustical sound control under ceramic tile and stone
- Prevents the transfer of subfloor cracks to the finished floor
- Reduces thermal transmission, increasing effectiveness of floor heating systems
- Can also be used under laminate and floating floors
- Easy to install on and above grade in both glue-down and floating floor installations



Item No.	Description	Case Qty	Packaging
72019	1/4" [6 mm] Sheets - 30 sq. ft./pack	8	Sheets
72002	1/4" [6 mm] Roll - 200 sq. ft. roll, 48" x 50"	1	Roll



	Test Results	IIC Rating*	STC Rating**	Δ Rating***	R-Value
72019	Engineered wood on a 6" cement slab	73	70	22	0.187
72002	Engineered wood on a 6" cement slab	73	70	22	0.187

*IIC measures sound such as moving furniture and walking, **STC measures sound such as voices and television. Minimum sound rating required by most building codes and architects is 50. ***Δ Delta Rating is the only true measurement of sound reduction from a product (not a floor assembly) in the industry.

Natural Cork Sheets



- Reduces sound transmission from both the surface of a floor as well as through the floor to living spaces below
- Use under ceramic tile, stone, marble, engineered hardwood and laminate floors
- Acts as a crack isolation membrane that resists transfer of stress cracks from subfloor through to flooring surfaces
- Reduces thermal transmission, increasing the effectiveness of floor heating systems
- Each sheet: 2' x 3'



CERTIFIED BY
FSC Global Services

	Test Results	IIC Rating*	STC Rating**	Δ Rating***
72005Q	With 6" cement slab and suspended ceiling	74	70	22

Item No.	Description	Case Qty	Packaging
72005Q	1/4" (6 mm) Sheets - 30 sq. ft./pack, (5 sh/pk)	8	Shelf Case
72001Q	1/2" (12 mm) Sheets - 150 sq. ft./case, (25 sh/cs)	1	Shelf Case

Natural Cork Roll



- Reduces sound transmission from both the surface of a floor as well as through the floor to living spaces below
- Use under ceramic tile, stone, marble, engineered hardwood and laminate floors
- Acts as a crack isolation membrane that resists transfer of stress cracks from subfloor through to flooring surfaces
- Reduces thermal transmission, increasing the effectiveness of floor heating systems



CERTIFIED BY
FSC Global Services

	Test Results	IIC Rating*	STC Rating**	Δ Rating***
72000Q	With 6" cement slab & suspended ceiling	74	70	22
72003Q	With 6" cement slab & suspended ceiling	74	70	22

Item No.	Description	Case Qty	Packaging
72000Q	1/4" (6 mm) Natural Cork 200 sq. ft. roll, 48" x 50'	1	Roll
72003Q	1/4" (6 mm) Natural Cork 100 sq. ft. roll, 48" x 25'	1	Roll

Aquabar® "B" Moisture Vapor Barrier



- Sub-floor barrier helps prevent buckling, cupping and cracking
- Ideal for interior installations of: ceramic, porcelain or stone over cement board, plywood or concrete; and, finished or unfinished wood floors over plywood or concrete

Item No.	Description	Case Qty	Packaging
70-195	Aquabar "B" Moisture Vapor Barrier - 500 sq. ft., 36" x 167'	1	Roll

*IIC measures sound such as moving furniture and walking, **STC measures sound such as voices and television. Minimum sound rating required by most building codes and architects is 50. ***Δ Delta Rating is the only true measurement of sound reduction from a product (not a floor assembly) in the industry.



STICK WITH US FOR A SURE STEP.

For permanent installations of carpet / vinyl flooring, to safety tread for stairs, or a non-slip grip to hold your rugs and mats in place, ROBERTS® offers a tape that meets your flooring needs.



MAX GRIP®
VINYL TAPE

Scan here for PRODUCT INFORMATION



- For permanent installation of vinyl flooring, wall base, stair, tread and vinyl trim



TREAD TAPE
ANTI-SLIP SAFETY STRIP

Scan here for PRODUCT INFORMATION



- Provides extra traction on stairs, ramps, loading docks and ladders



RUG GRIPPER™
FOR HIGH TRAFFIC INDOOR RUGS

Scan here for PRODUCT INFORMATION



- Offers non-slip strength to keep rugs and mats from bunching up or sliding across the floor



50-540
50-550

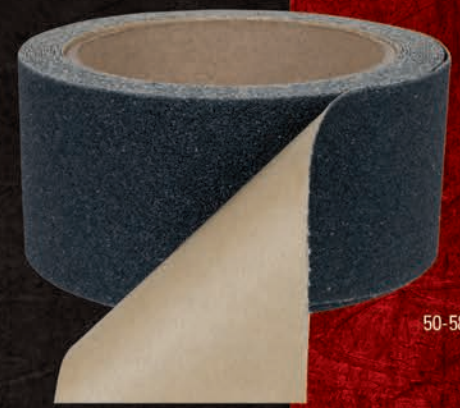

50-585



50-580
50-588



DISPLAYS & MERCHANDISING

We are pleased to offer both promotional floor stands and permanent fixtures for some of our best-selling installation tools. The floor displays are made of cardboard which can be recycled and the countertop displays can be used for any QEP product you would like to feature. Our 4' and 8' QEP branded gondola fixtures are designed to hold pegged product, shelf cartons and boxes. The gondola presentation allows for the full range of QEP tile tools to be merchandised together with overhead signage.

QEP Corrugated Floor Displays

Perfect for promotions or secondary placement.

Single Pack Sponge



252
Sponges
per display



70005D
Heavy Duty All Purpose
Single Pack Sponge Floor Display

3-Pack Sponge

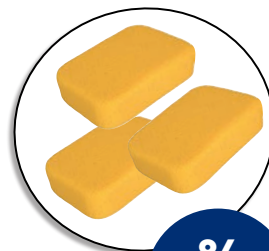

84
3-packs
per display



70005-3VPD
Heavy Duty All-Purpose
3-Pack Sponge Floor Display

Gel Knee Pads



20
Pairs
per display

79645D
ProMAX® Gel Knee Pad
Floor Display



Mixers

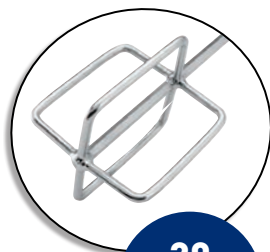

30
Mixers
per display



61205D
Pro Mixing Paddle
Floor Display



LASH® Project Pack



48
Project Packs
per display



99741D
LASH® Project Pack
Floor Display

Project Pack includes:

- 100 1/16" Flat Tile Leveling Clips
- 100 Leveling Wedges

Tile Tool Merchandising Displays

QEP is pleased to offer free displays that can be customized based on the product assortment of top-selling tools you carry! These portable gondolas are designed and merchandised to deliver incremental sales at high margins. Includes free branded header insert.

4' Tile Tool Merchandising Display



- Header is adjustable and measures 48" wide x 10" tall
- Display measures 48" wide x 26" deep x 72" high

QEP 4' Gondola
Item # QEP4FTGONDOLA
Sign - Item # 1170-361

← Example of 4' Planogram

FREE Display
with opening
order

\$500
Value

See your Sales Rep for more details

8' Tile Tool Merchandising Display



- Header is adjustable and measures 96" wide x 10" tall
- Display measures 96" wide x 26" deep x 72" high

FREE Display
with opening
order

\$1000
Value

See your Sales Rep for more details

QEP 8' Gondola
Item # QEP8FTGONDOLA
Sign - Item # 1170-351

← Example of 8' Planogram

Tile Tool Merchandising Displays

QEP is pleased to offer counter top displays that can be customized based on the product assortment you carry! These displays should be merchandised near check out for incremental sales. All displays includes free branded header insert.

Counter Display



- Vertical display measures 18.85" wide x 15.68" deep x 33.75" high
- QEP Xtreme Hole Saws are an example of product assortment that can be displayed on this fixture.

Item # HSCTD4W
Sign # HSCTD4SIGN

**FREE Display
with opening
order**

**\$48
Value**

See your Sales Rep for more details

Gravity Display



- Silicone injected hook design allows product to slide to front
- Vertical display measures 27.28" wide x 11.92" deep x 18.70" high
- QEP Xtreme Hole Saws are an example of product assortment that can be displayed on this fixture.

Item # HSCTD5W
Sign # HSCTD5SIGN

**FREE Display
with opening
order**

**\$52
Value**

See your Sales Rep for more details

INDEX *By Item Number*

Item #	Description	Page
6-1001Q	10" Continuous Rim Diamond Blade- Black Series	53
6-1003Q	10" Continuous Rim Diamond Blade- Gold Series	53
6-1008BW	10" Black Widow® Blade	52
6-4001Q	4" Continuous Rim Diamond Blade- Black Series	53
6-4003Q	4" Continuous Rim Diamond Blade- Gold Series	53
6-4006GLQ	4" Continuous Rim Diamond Blade- Glass Series	53
6-4008BW	4" Black Widow® Blade	52
6-7001Q	7" Continuous Rim Diamond Blade- Black Series	53
6-7003Q	7" Continuous Rim Diamond Blade- Gold Series	53
6-7007GL	7" Continuous Rim Diamond Blade- Glass Series	53
6-7008BW	7" Black Widow® Blade	52
6-8001Q	8" Continuous Rim Diamond Blade- Black Series	53
6-8003Q	8" Continuous Rim Diamond Blade- Gold Series	53
6-8008BW	8" Black Widow® Blade	52
70-195	Aquabar® "B" Moisture Vapor Barrier	64
10003	Tile Nipper	20
10005	1/4" Tile Spacers, Bag - 200 Qty	15
10010HD	Tungsten Carbide Cutting Wheel	41
10020	Grout Remover	28
10022	Rubbing Stone	26
10027	3/8" Tile Spacers, Bag - 100 Qty	14
10038	6" Locking Contour Gauge	20
10038C	6" Locking Contour Gauge (Canada Only)	20
10046	Diamond Sanding Block, 60 grit	26
10047	Diamond Sanding Block, 120 grit	26
10048	Diamond Sanding Block, 200 grit	26
10049	Diamond Sanding Block, 400 grit	26
10051	Xtreme 3/8" Diamond Milling Bit	23
10052	Xtreme 3/4" Diamond Milling Bit	23
10057	Grout Saw	27
10057C	Grout Saw (Canada Only)	27
10058	Backerboard Scoring Knife	31
10060	Molded Rubber Grout Float 9-1/2" x 4"	8
10062	Grout Float 9-1/2" x 4"	8
10066	Xtreme 3/4" Diamond Milling Cone	23
10069	Xtreme Stone Grout Float	7
10070	Gum Rubber Grout Float, Wood Handle	8
10071	Xtreme 3/16" Diamond Hole Saw	22
10072	Folding Backerboard Knife	31
10074-8	Universal Grout Float 9-1/2" x 4"	7
10075	Xtreme 1/4" Diamond Hole Saw	22
10080	Xtreme 5/16" Diamond Hole Saw	22
10087	Xtreme 1-3/8" Diamond Hole Saw	22

Item #	Description	Page
10093	Pro Grout Saw	27
10093C	Pro Grout Saw (Canada Only)	27
10103	Xtreme Pro Series Offset Tile Nipper	19
10113	Standard Trowel 1/4" x 1/4" x 1/4"	5
10114	Standard Trowel 1/4" x 3/8" x 1/4"	5
10115	Standard Trowel 3/16" x 5/32" V	5
10116	Standard Trowel 1/4" x 3/16" V (Canada Only)	5
10120	Standard Trowel 1/2" x 1/2" x 1/2"	5
10202	1/16" "T" Tile Spacers	15
10203	1/8" "T" Tile Spacers	15
10204	3/16" "T" Tile Spacers	15
10214Q	14" Pro Tile Cutter	41
10220Q	20" Pro Tile Cutter	41
10221Q	21" Pro Tile Cutter	41
10279	Grout Sealer Applicator	28
10285	Wedge Tile Spacers, Bag - 500 Qty	15
10320	1/16" Horseshoe Shims - 200 Qty	14
10321	1/8" Horseshoe Shims - 150 Qty	14
10322	3/16" Horseshoe Shims - 100 Qty	14
10323	1/4" Horseshoe Shims - 75 Qty	14
10324	1/16" Leave-In Spacers, Jar - 1500 Qty	16
10325	1/8" Leave-In Spacers, Jar - 1000 Qty	16
10326	3/16" Tile Spacers, Jar - 500 Qty	16
10330-20	1/16" Leave-In Spacers Bag	16
10331-18	1/8" Leave-In Spacers Bag	16
10332	3/16" Leave-In Spacers, Bag - 200 Qty	16
10333	1/4" Leave-In Spacers, Bag - 200 Qty	16
10334	1/16" Tile Spacers, Bag - 300 Qty	15
10335	1/8" Tile Spacers, Bag - 500 Qty	15
10336	3/16" Tile Spacers, Bag - 300 Qty	15
10451	1/8" Paver Spacers 20 pack	16
10468	Xtreme 3/16" Hole Saw for grinder	23
10469	1/4" Xtreme Hole Saw for grinder	23
10470	5/16" Xtreme Hole Saw for grinder	23
10471	1" Xtreme Hole Saw for grinder	23
10472	1-3/8" Xtreme Hole Saw for grinder	23
10473	2" Xtreme Hole Saw for grinder	23
10474	2-1/2" Xtreme Hole Saw for grinder	23
10475	4" Xtreme Hole Saw for grinder	23
10480Q	48" LFT Manual Cutter	40
10485	Xtreme Diamond Hole Saw Kit	22
10500	22-1/2" Big Clinker Tile Cutter	39
10569	1-3/8" Porcelain Diamond Hole Saw w/Drill Guide & Water Cooling System	21

INDEX *By Item Number Continued*

Item #	Description	Page	Item #	Description	Page
10570	1-3/8" Hole Saw Mounting Tape	21	42113-6	Bucket Scoop (Canada Only)	7
10571	5/16" Porcelain Diamond Drill Bit w/Drill Guide & Water Cooling System	21	42114	6" x 2" Comfort Grip Margin Trowel Square Notch 1/4" x 1/4" x 1/4"	6
10572	1/4" Porcelain Diamond Drill Bit w/Drill Guide & Water Cooling System	21	42117	6" Comfort Grip Margin Float	8
10585	3" Diamond Jigsaw Blade	21	49708	Patch & Finishing Trowel 11" x 4-1/2"	6
10586-6	Diamond Grit File	27	49713	Wood Handle Trowel Square Notch 1/4" x 1/4" x 1/4"	5
10600	25" Big Clinker Tile Cutter	39	49714	Wood Handle Trowel Square Notch 1/4" x 3/8" x 1/4"	5
10624Q	24" Slimline Manual Tile Cutter	38	49716	Wood Handle Trowel V Notch 1/4" x 3/16"	5
10630	24" Pro Tile Cutter	40	49720	Wood Handle Trowel Square Notch 1/2" x 1/2" x 1/2"	5
10632Q	30" Slimline Manual Tile Cutter	38	49915-12	Comfort Grip Stainless Steel Trowel Square Notch 1/4" x 1/4" x 1/4"	5
10636Q	36" Slimline Manual Tile Cutter	38	49916-12	Comfort Grip Stainless Steel Trowel Square Notch 1/4" x 3/8" x 1/4"	5
10711	Multi-Use Trim Shears	29	49917-12	Comfort Grip Stainless Steel Trowel V Notch 3/16" x 5/32"	5
10715	Tile Trim Square	29	49919-12	Comfort Grip Stainless Steel Trowel Square Notch 1/2" x 1/2" x 1/2"	5
10800	28" Big Clinker Tile Cutter	39	49950-12	Xtreme Cork Handle Trowel Square Notch 1/4" x 1/4" x 1/4"	5
10900	35" Pro Tile Cutter	40	49951-12	Xtreme Cork Handle Trowel Square Notch 1/4" x 3/8" x 1/4"	5
19999	Grout Sealer Brush Applicator	28	49952-12	Xtreme Cork Handle Trowel Square Notch 1/2" x 1/2" x 1/2"	5
20839	Large Handle Scrub Brush	35	49953-12 (Canada Only)	Xtreme Cork Handle Trowel Square Notch with ruler 1/4" x 1/4" x 1/4"	5
20842	Grout Cleaning Brush	35	49954-12 (Canada Only)	Xtreme Cork Handle Trowel Square Notch with ruler 1/4" x 3/8" x 1/4"	5
20842C	Grout Cleaning Brush (Canada Only)	35	49955-12 (Canada Only)	Xtreme Cork Handle Trowel Square Notch with ruler 1/2" x 1/2" x 1/2"	5
20900Q	14" Surface Scraper	56	61205	23-1/2" Pro Mixing Paddle	18
20902C	14" Surface Scraper (Canada Only)	56	61205D	23-1/2" Pro Mixing Paddle Floor Display	67
21000Q	14" Replacement Blade	56	61210	Universal Mixing Paddle	18
21123Q	7/8" Titanium-Coated Tungsten Carbide Cutting Wheel	42	61230	30" XL Spiral Pro Mixer	18
21125	7/8" Titanium-Coated Tungsten Carbide Cutting Wheel	42	61613	White Rubber Mallet	30
21127Q	10 mm Post Scoring Wheel	42	61625	Tile Mallet	30
21178	7/8" Titanium-Coated Tungsten Carbide Cutting Wheel	42	61900Q	10" 900XT Pro Wet Tile Saw	47
21591	Heavy Duty Multipurpose Gloves	35	62901	4" Razor Scraper Replacement Blades (5 pack)	58
21595	SureGrip® Tiler's Gloves (2 pairs of gloves)	35	62904Q	8" Stripper Blade (3 pack)	57
21661	24" Pro Mixing Paddle	18	62907Q	8" Stripper Blade (10 pack)	57
21700	Power Mixer Pro w/Paddle	18	62909Q	8" Adjustable Razor Floor Stripper (10 pack)	57
22400Q	4" Torque Master XT Portable Wet Tile Saw	51	62909QC	8" Adjustable Razor Floor Stripper (10 pack) (Canada Only)	57
22700Q	7" 700XT Wet Tile Saw	50	62920	4" Razor Scraper	58
22750Q	7" 750XT Wet Tile Saw	49	62920C	4" Razor Scraper (Canada Only)	58
22900Q	7" Power Pro 1HP Wet Tile Saw	48	62963	Thinset Removal Tool	28
32010	Glass Tile Nipper	19	62963C	Thinset Removal Tool (Canada Only)	28
32014	Xtreme Glass Tile Nipper	19	62965Q	Demolition Scraper	57
32024	Tile Cutter	20	62971	Xtreme Heavy Duty Chisel	58
32036	Compound Tile Nipper	19	62972	Chisel Scraper	58
38229	Toilet Installation Kit with 12" Connector	36	62972C	Chisel Scraper	58
38779	Wax China Markers - 2 Pack - 1 black/1 red	20			
42112	6" x 2" Comfort Grip Margin Trowel	6			
42113	Bucket Scoop	7			

INDEX *By Item Number Continued*

Item #	Description	Page
70005	XL All-Purpose Sponge, Bale (Canada Only)	32
70005D	All-Purpose Heavy Duty Single Pack Sponge Floor Display	32
70005Q-6D	All-Purpose Heavy Duty Sponge, Value 6 Pack	32
70005-24	All-Purpose Heavy Duty Sponge, 24 ct Case	32
70005C-24	All-Purpose Heavy Duty Sponge, 36 ct Case (Canada Only)	32
70005-750	All-Purpose Heavy Duty Sponge Bale	32
70005-3VPD	All-Purpose Heavy Duty 3- Pack Sponge Floor Display	67
70006-18	Pro Square Grouting Sponge	32
70007-24	Scrubbing Sponge	33
70007C-24	Scrubbing Sponge	33
70010	Microfiber Polishing Sponge	33
70010C-24	Microfiber Polishing Sponge	33
70018	Microfiber Grout Cleaning Cloth 18" x 18"	34
70019	Microfiber Surface Cleaning Cloth 14" x 14" 2-pack	34
72000Q	1/4" Natural Cork 6 mm Roll 200 sq ft	64
72001Q	1/2" Natural Cork 12 mm Sheets 150 sq ft	64
72002	1/4" Cork Plus 6 mm Roll 200 sq ft	63
72003Q	1/4" Natural Cork 6 mm Roll 100 sq ft	64
72005Q	1/4" Natural Cork 6 mm 2' x 3' Sheets 30 sq ft	64
72019	1/4" Cork Plus 6 mm Sheets 30 sq ft	63
73000	Backerboard 1/4" 36" x 60" Full Container Only	30
73001	Backerboard 1/4" 48" x 96" Full Container Only	
73002	Backerboard 1/2" 36" x 60" Full Container Only	30
73005	Backerboard 1/8" 36" x 60" Full Container Only	30
75000	Suction Cup	25
75001Q	23-1/2" Thinset and Grout Paddle	18
75003	Double Suction Cup	25
75006Q	7" Heavy-Duty Floor Scraper	56
75007Q	7" Replacement Blade	56
75011	Replacement Grout Saw Blades (2 pack)	27
75012	Xtreme Pro Series Double Suction Cup	25
75013	ProMAX® GRIP Double Suction Cup	25
75017C	7" Heavy-Duty Floor Scraper with Blade (Canada Only)	56
75021	8" Vacuum Pump Suction Cup	24
75022	8" Pump Suction Cup with Gauge	24
75024	Xtreme 8" 8" Electric Suction Cup with Digital LED	24
75025	Large Format Manual Cutting System	43
75026	Large Format Electric Cutting System	43
75027	Working Bench	44

Item #	Description	Page
75028	Trade Carrier System	44
75029	Transport Cart	45
75030	Mitre Jolly Cutting System	44
75031	CVT Vibration Tile Beater	45
75032	Square Beating Block	45
76000	Grout Bag	29
76030	Polishing Cheesecloth	34
78105	5 Gallon Plastic Mixing Bucket-white with QEP logo	34
78220Q	Tile Installation Kit	36
78220C	Tile Installation Kit (Canada Only)	36
78251	Floor & Wall Tile Installation Kit	36
79634	Comfort Grip Knee Pads	60
79640	Washable Knee Pads	61
79642	F3 Stabilizer Professional Knee Pads	61
79645	ProMAX® Gel Knee Pads	60
79645D	ProMAX® Gel Knee Pad Floor Display	67
99600	Board Seam Tape	31
99605	Cement Board Seam Tape	31
99703	LASH® Wedges 3600 Qty Contractor Pack	14
99707Q	LASH® 1/16" Clips 4800 Qty Contractor Pack	14
99726	LASH® Wedges, Bag 100 Qty	14
99727	LASH® Wedges, Box 300 Qty	14
99730	LASH® 1/16" Clips, Bag 100 Qty	14
99731	LASH® 1/16" Clips, Box 300 Qty	14
99734	LASH 360 Caps, Bag, 100 Qty	13
99735	1/16" LASH 360 In-line, Bag, 100 Qty	13
99736	1/16" LASH 360 3-Corner, Bag, 100 Qty	13
99737	1/16" LASH 360 4-Corner, Bag, 100 Qty	13
99740	LASH® 1/16" Clips, Box 1000 Qty	14
99741D	LASH® Project Pack Floor Display	67
99761	Xtreme 1/16" Leveling Clips, Bag 100 Qty	10
99762	Xtreme Leveling Wedges, Bag 100 Qty	10
99769	Xtreme 3/16" Leveling Clips, Bag 100 Qty	10
99771	Xtreme 1/32" Leveling Clips, Box 500 Qty	10
99772	Xtreme 1/16" Leveling Clips, Box 500 Qty	10
99773	Xtreme 1/8" Leveling Clips, Box 500 Qty	10
99774	Xtreme 3/16" Leveling Clips, Box 500 Qty	10
99775	Xtreme Leveling Wedges, Box 500 Qty	10
99776	Xtreme 1/32" Leveling Clips, Box 2000 Qty	10

INDEX By Item Number Continued

Item #	Description	Page	Item #	Description	Page
99777	Xtreme 1/16" Leveling Clips, Box 2000 Qty	10	1170-351	QEP 8' Gondola Sign	68
99778	Xtreme 1/8" Leveling Clips, Box 2000 Qty	10	QEP4FTGONDOLA	QEP 4' Gondola	68
99779	Xtreme 3/16" Leveling Clips, Box 2000 Qty	10	1170-351	QEP 4' Gondola Sign	68
99780	Xtreme Leveling Wedges, Box 2000 Qty	10	HSCTD4W	QEP Counter Display	69
99781	LASH® 1/8" Flat Clips, Bag 100 Qty	14	HSCTD4SIGN	QEP Counter Display Sign	69
99782	LASH® 1/8" Flat Clips, Box 300 Qty	14	HSCTD5W	QEP Gravity Display Sign	69
99783	LASH® 1/8" Flat Clips, Box 1000 Qty	14	HSCTD5SIGN	QEP Gravity Display Sign	69
99784	Pro Installation Pliers	10	SPACER PALLETS	Xtreme 500 count Clips and Wedges	11
99784C	Pro Installation Pliers (Canada Only)	10	SPACER PALLETS	Xtreme 2000 count Clips and Wedges	11
QEP8FTGONDOLA	QEP 8' Gondola	68	SPACER PALLETS	LASH® 360 Caps and In-line Stems	12

QEP Warranty

All QEP products include a Manufacturer's Limited Warranty ensuring the product is free from defects in materials and workmanship for a period of one-year from the date of purchase. This warranty does not cover accidental damages, unreasonable or improper use, normal wear and tear, loss of use, or consequential damages. Some items, such as electric tile saws, mixers and cutters, carry a QEP 1-Year Limited Warranty. Product registration, included with the product packaging, must be completed within 30 days of purchase for eligibility. This warranty covers refund or replacement due to a defect in materials or workmanship for a term of one year.

About California Proposition 65

Proposition 65 is a California regulatory law that requires businesses to notify California consumers about specific chemicals in the products they purchase so they can make informed decisions about protecting themselves from exposure to these chemicals. This law requires companies to properly label products that contain chemical(s) above certain threshold levels.

As part of QEP Co. Inc.'s continued best business practice and compliance program, we comply with Proposition 65 warning requirements and provide product-associated warnings. We are dedicated to meeting consumer product safety requirements applicable to our products and strive to provide high quality and safe products.

For more information on California Proposition 65, go to www.P65Warnings.ca.gov.

- *Prop 65 - 1. **⚠️ WARNING:** This product can expose you to chemicals including DEHP which is known to the State of California to cause cancer, birth defects or other reproductive harm.
- *Prop 65 - 2. **⚠️ WARNING:** This product can expose you to chemicals including N, N-Dimethylformamide, which is known to the State of California to cause cancer, birth defects and other reproductive harm.

QEP®, LASH® and Black Widow® are registered trademarks of QEP Co., Inc.

Aquabar® "B" is a registered trademark of Fortifiber LLC.

Fluidmaster® is a registered trademark of Fluidmaster, Inc.

No-Seep® is a registered trademark of William H. Harvey Co.

ROBERTS® Max Complete® is a registered trademark of Roberts Consolidated Industries, Inc.

Rug Gripper™ is a trademark of Optimum Technologies, Inc.

The products, specifications, and Prop 65 Warnings listed in this catalog are current as of the printed date of this catalog and are subject to change. Access product data sheets, technical bulletins, warranties and SDS documents 24 hours a day, 7 days a week through our continuously updated website.

STATE-OF-THE-ART FACTORIES

Specializing in **Automation** and
Large Injection Molding



Laser Etching



Large Injection Molding



SUPPORTING THE FUTURE OF OUR INDUSTRY



WE ARE ALL IN THIS TOGETHER!

ENCOURAGE YOUR LOCAL INSTALLERS TO GET TRAINING AND CERTIFICATIONS.

BENEFITS TO YOUR BUSINESS INCLUDE:

- Have confidence in customer satisfaction when you recommend qualified industry professionals for installations
- Open opportunities for a wider variety of projects to both your customers and your installers
- Be the go-to place for specialized installation jobs

GET THE WORD OUT!

- Let the next generation know about installation as a career option
- Support existing local high school and college programs
- Start the discussion if local programs don't exist

WHAT ELSE CAN YOU DO?

- Host a training at your facility
- Sponsor training for an up and coming young installer
- Donate time or even leftover product from a finished job to a local training organization





QEP

1001 Broken Sound Parkway, NW
Boca Raton, Florida 33487

qep.com | qepcorporate.com

For more information call 866-435-8665

Se habla español

SCAN HERE FOR
ONLINE CATALOG



PROFESSIONAL
TOOLS
FOR PROFESSIONAL
RESULTS



QEPTOOL2024 – H2424 12252

Our 2024 QEP catalog cover features Natalia Mestre, QEP Product Manager, demonstrating the 4" Xtreme Diamond Hole Saw