



# CERAMIC & STONE INSTALL TOOLS

# 2025





## KEY MILESTONES

- 1979** Company is founded
- 1980** QEP opens first official corporate facility
- 1984** QEP releases the world's first dual rail tile cutter
- 1986** Named a member of Inc. Magazine's 500 second year in a row
- 1989** QEP begins manufacturing tile spacers
- 1990** Founder interviewed by "Ceramic Tiling Tools"
- 1999** QEP available in all 50 states and 49 countries worldwide
- 2003** A QEP brand sponge is now sold every 7 seconds
- 2004** European expansion in England, Ireland and France
- 2010** QEP begins Sponge Production in the US
- 2011** First to market with the LASH style leveling system
- 2014** The QEP 900XT Pro Tile Saw wins Surfaces 2014 Best New Product Award
- 2022** QEP consolidates shipping and opens new 212,000 sq. ft. warehouse and shipping facility in Dalton, Georgia
- 2022** Filed Patent for LASH Xtreme Large Tile Leveling System
- 2022** Filed Patent for Single Action Dual Suction Cup
- 2022** Filed Patent for Cork Handled Trowels
- 2024** The QEP Tile Trim Square wins FLOOR Trends & Installation's 2024 Top Flooring Products Award

QEP® was founded in 1979 with a vision of excellence in tile installation tools and impeccable timing: At the rise of home improvement industry, and the boom of the DIY movement. Today, through innovation and ingenuity, QEP is the #1 Tile Tool Brand Worldwide.

An iconic, trusted brand for the world's largest retailers and flooring distributors, QEP continues to expand their product line with best-in-class product design, eco-friendly packaging, and optimal trend merchandising.

We are continuing to work to ensure that we are fulfilling the needs of the professional installers of today and tomorrow.

## A Brand You Can Trust

QEP is an iconic brand with an established market in more than 100 countries, it is founded on decades of experience in the industry, fosters true partnerships with national trade affiliates and training certification partners, and is committed to exceeding your expectations.

- Award-winning, multilingual Customer Service Team
- Expert-level technical support to receive and resolve your product and industry questions
- Research and Development Team dedicated to improving, advancing, enhancing, and innovating our products through best-in-class engineering
- Partnership with industry affiliates including NTCA, TCNA, CTEF, FCEF, FCICA, WFCA, AFT and IUPAT among others, to support and invest in the trade and the future of the industry
- 600K Sq. Ft. of warehouse and manufacturing space ensures that we are always in stock, inventory is always available
- Dedicated social media and brand ambassador programs to ensure that we are speaking with and engaging with the installer of today

## QEP's Commitment to Sustainability

We are always challenging ourselves to reimagine the design of products and packaging to ensure that we are using materials which are recycled, biodegradable or otherwise earth friendly.

---

**Professional Tools for Professional Results**  
**Since 1979**

---

Se habla español | français parlé



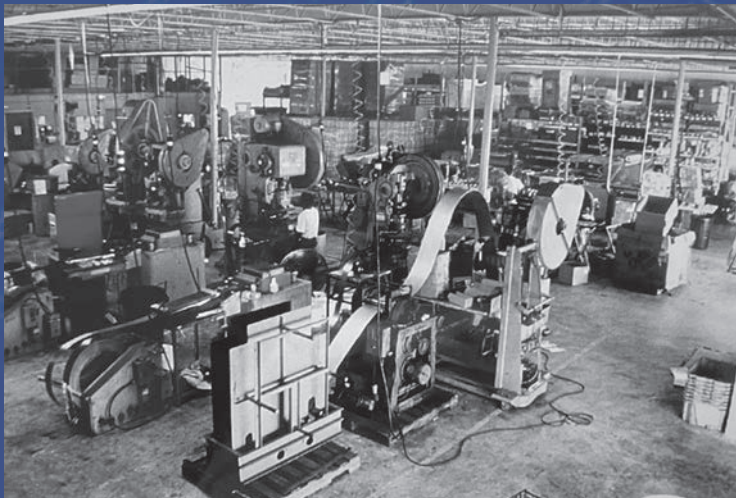
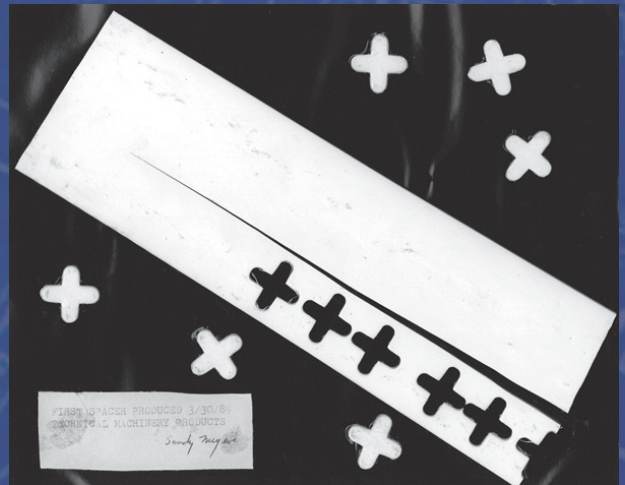

The ORIGINAL **LASH**®  
LEVEL ALIGN SPACE HOLD

## The World's Best Tile Leveling System

US007992354B2

(12) United States Patent (10) Patent No.: US 7,992,354 B2  
Doda, Jr. (45) Date of Patent: Aug. 9, 2011

(54) DEVICE FOR LEVELING AND ALIGNING TILES AND METHOD FOR LEVELING AND ALIGNING TILES

(75) Inventor: Robert C. Doda, Jr., Pompano Beach, FL (US)

(73) Assignee: Q.E.P. Co., Inc., Boca Raton, FL (US)

(\*) Notice: Subject to any disclaimer, the term of this patent is extended or adjusted under 35 U.S.C. 154(b) by 182 days.

(21) Appl. No.: 12479,175

(22) Filed: Mar. 24, 2008

(65) Prior Publication Data  
US 2008/0236094 A1 Oct. 2, 2008

Related U.S. Application Data  
(60) Provisional application No. 60/920,430, filed on Mar. 26, 2007.

(51) Int. Cl. E04F 21/20 (2006.01)

(52) U.S. Cl. 52/27.7; 52/749.11; 52/747.11

(58) Field of Classification Search: 52/127.3; 52/127.7; 52/127.9; 52/127.3; 52/127.7; 52/127.9; 52/749.11; 52/747.11; 52/749.11; 749.15; 506.7; 33/226  
See application file for complete search history.

(56) References Cited

U.S. PATENT DOCUMENTS

2,080,190 A	*	5/1937	Sauer	52/698
2,562,312 A	*	11/1956	Hansen et al.	52/750
3,234,692 A	*	2/1966	Kanal	52/792
4,397,125 A	*	8/1983	Gustaf, Jr.	52/173.5
4,503,454 A	*	3/1985	Cozzitini	52/747.11
4,933,541 A	*	9/1990	Joos	52/747.11
5,335,566 A	*	7/1996	Wilson et al.	52/966.07

FOREIGN PATENT DOCUMENTS

IT	MI02024000015	8/2005
WO	WO/92/4012	8/1992
WO	WO/2006/091606 A2	8/2006

OTHER PUBLICATIONS

International Search Report dated Jul. 16, 2008 for International Application No. PCT/US2008/003648

Edward, Charles, Certified English Language Translation of Italian Patent Publication No. ITM02024000015, published Aug. 16, 2003; dated Mar. 23, 2011, 18 Pages.

\* cited by examiner

Primary Examiner — David Dunn  
Assistant Examiner — Alp Akhondi

(74) Attorney, Agent, or Firm — Christie, Parker & Hale, LLP

(57) ABSTRACT

A tile leveling device is provided. The device includes a main member, a first section extending transversely from the main member for receiving a first tile and a second section extending transversely from the main member in a direction opposite the first section for receiving a second tile. A member is provided for penetrating the main member and exerting a force on the tiles for leveling them relative to each other. A method for leveling tiles is also provided.

10 Claims, 6 Drawing Sheets





# UNPARALLELED COMMITMENT TO QUALITY, PERFORMANCE AND PARTNERSHIP

At QEP®, our success is measured in the reliability of our tools, the satisfaction of our customers and the trust placed in the brand by the professional installers and customers that use them.

## QUALITY

### WORLD-CLASS MANUFACTURING & INNOVATION

In pursuing this success, we have invested in building relationships with some of the world’s foremost experts in industrial design, manufacturing, and tooling. Rigorous quality-assurance measures have been put in place to ensure every product that carries our brand exceeds the expectation of our customers.

## PERFORMANCE

### SATISFACTION GUARANTEED

At QEP customer satisfaction is paramount, which is why we offer a ‘best in class’ warranty program. All QEP electric tile saws, mixers, tile cutters, and the electric suction cup carry a 3 year Manufacturer’s Limited Warranty. All QEP hand tools carry a 1-year Manufacturer’s Limited Warranty ensuring the product is free from defects in materials and workmanship. Visit us online at [qep.com](http://qep.com) for individual warranty terms and details.

## PARTNERSHIP

### INVESTING IN OTHERS

Success does not happen by accident. At QEP, success has been the result of working with passionate, like-minded people that share our commitments and goals. In partnering with installers, trade affiliates and certification partners, we not only ensure that we’re developing products that meet the needs of generations of installers, we are investing in the future of the trade itself.

#### AFFILIATES:



WORLD FLOOR COVERING ASSOCIATION









# CONTENTS

## GAUGED PORCELAIN TILE PANEL SOLUTIONS™

GPTP™ RAIL CUTTING SYSTEM, FOLDING WORK TABLE, CARRYING SYSTEM,  
TRANSPORT CART, VIBRATING SUCTION CUP

07

## TILE CUTTERS

CUTTERS, SCORING WHEELS, RAIL SYSTEMS

13

## TILE SAWS & DIAMOND BLADES

21

## TILE SPACERS

TILE LEVELING SYSTEMS, HORSESHOE SHIMS, TRADITIONAL & LEAVE-IN SPACERS

30

## TROWELS & FLOATS

36

## DIAMOND TOOLS

DIAMOND HOLE SAWS, SANDING BLOCKS, MILLING BITS & GROUT REMOVAL TOOLS

43

## INSTALLATION & BACKERBOARD TOOLS

MIXERS, NIPPERS, SUCTION CUPS, MALLETS, SPONGES, KNIVES, SEAM TAPE,  
BACKERBOARD

49

## TEAR-OUT TOOLS

SCRAPERS

67

## KNEE PADS

71

## UNDERLAYMENTS & BARRIERS

CORK, AQUABAR®

74

## DISPLAYS & MERCHANDISING

GONDOLAS, COUNTER DISPLAYS, GRAVITY DISPLAYS, FLOOR DISPLAYS, PALLETS

76





# GAUGED PORCELAIN TILE PANEL SOLUTIONS™

QEP® offers GPTP™ Solutions designed for handling and cutting large tile panels. The QEP GPTP™ Solutions product series includes a GPTP™ Rail Cutting System, Folding Work Table, Carrying System, Transport Cart and Vibrating Suction Cup. When working with large tile panels, these specialized tools are crucial for ensuring precise cuts, safe handling, and efficient installation. They are designed to handle the increased weight and size of large tile panels, making the tiling process more manageable and producing professional results.



# GPTP™ Rail Cutting System - 10'

**NEW-AVAILABLE  
JUNE 2025**

Perfect Solution for cutting porcelain panels up to 10' long and 3/8" thick

Rail Carry Bag



Rails

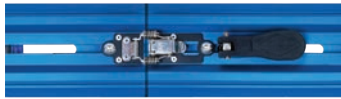
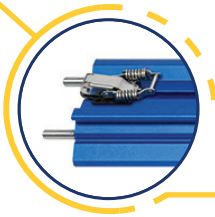

Spring clips for quick and easy length extension

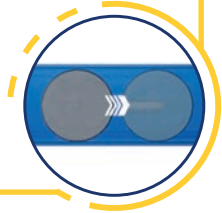
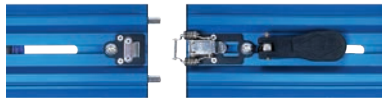

Four adjustable non-marring suction cups underneath each rail



Accessory Bag



Breaker Bar



Cutting Head

- 10' Under mount rail system with (3) 3'-6" rails featuring spring clips for quick and easy length extension
- Each rail is equipped with four non-marring suction cups allowing alignment and stability by maintaining consistent pressure while scoring smooth to semi- textured tiles
- The Cutting Head features reversible cutting wheel placement and a Palm Pad for added power and control.
- The Breaker Unit includes adjustable leverage points, small internal tips for thin cuts and a slide handle for increased breaking leverage
- Includes 2 carrying bags- one for breaker unit and cutting head and a separate bag for the rails



Item No.	Description	Case Qty	Packaging
75025	GPTP™ Rail Cutting System	1	Carton





**Adjustable knobs  
allow consistent  
breaking force**



**Slide handle  
for increased  
breaking leverage**



**Adjustable  
leverage points  
and small tips for  
thin cuts**



**Reversible cutting  
wheel placement**



**Palm pad for  
increased power  
and control**



**SCAN HERE** FOR MORE PRODUCT INFORMATION





# GPTP™ Folding Work Table - 5' x 6' x 32"

**NEW-AVAILABLE  
JUNE 2025**

440 lb. load capacity with quick connecting brackets for additional tables

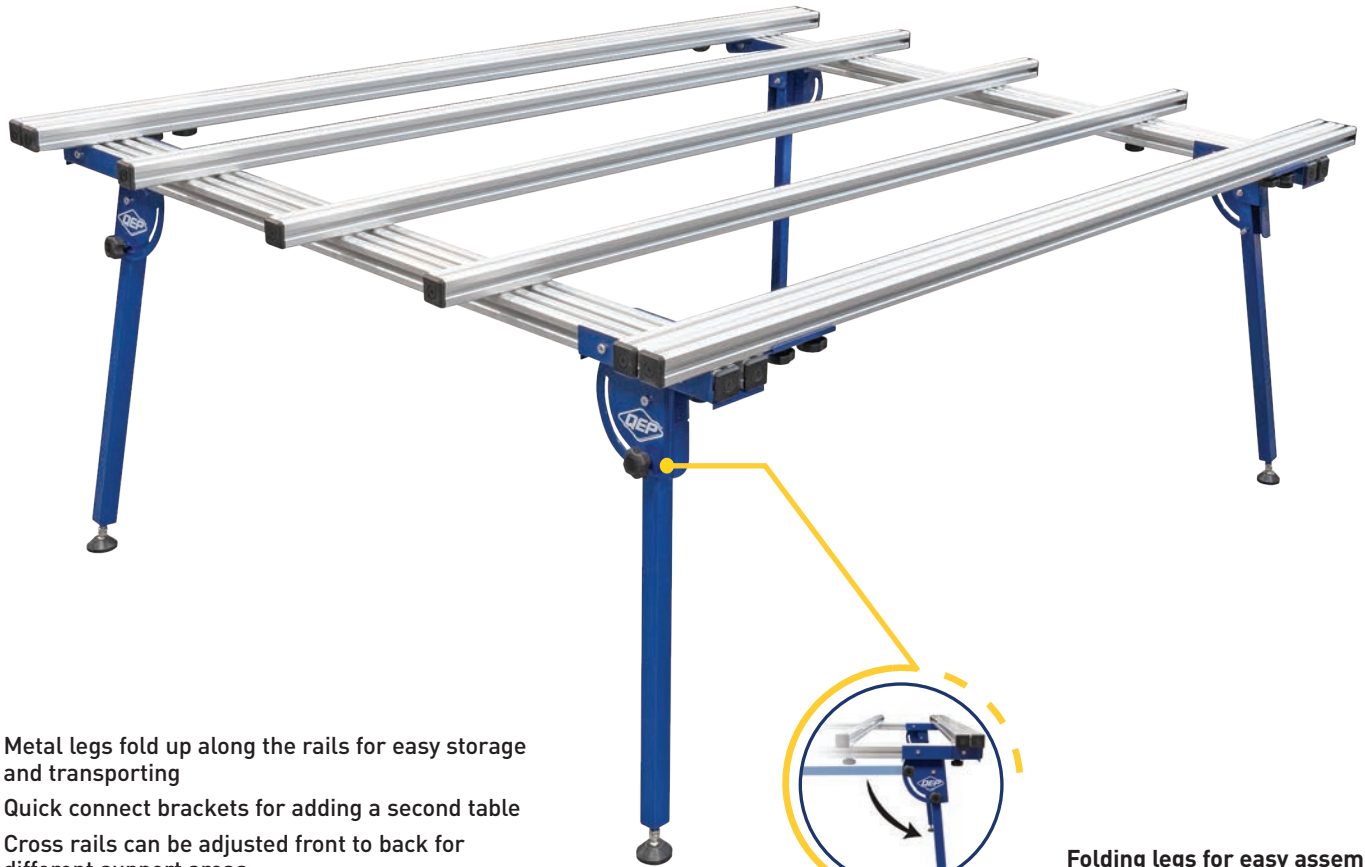

- Metal legs fold up along the rails for easy storage and transporting
- Quick connect brackets for adding a second table
- Cross rails can be adjusted front to back for different support areas
- 2" wide leveling feet
- 12" laser etched increments help line up cross support rails

Folding legs for easy assembly



Quick connector to connect two tables



Item No.	Description	Case Qty	Packaging
75027	GPTP™ Folding Work Table	1	Carton



SCAN HERE FOR MORE PRODUCT INFORMATION



# GPTP™ Carrying System

**NEW-AVAILABLE  
JUNE 2025**

Lightweight carrying system features a 6-suction cup configuration, engineered for flexible operation through pump or electric suction

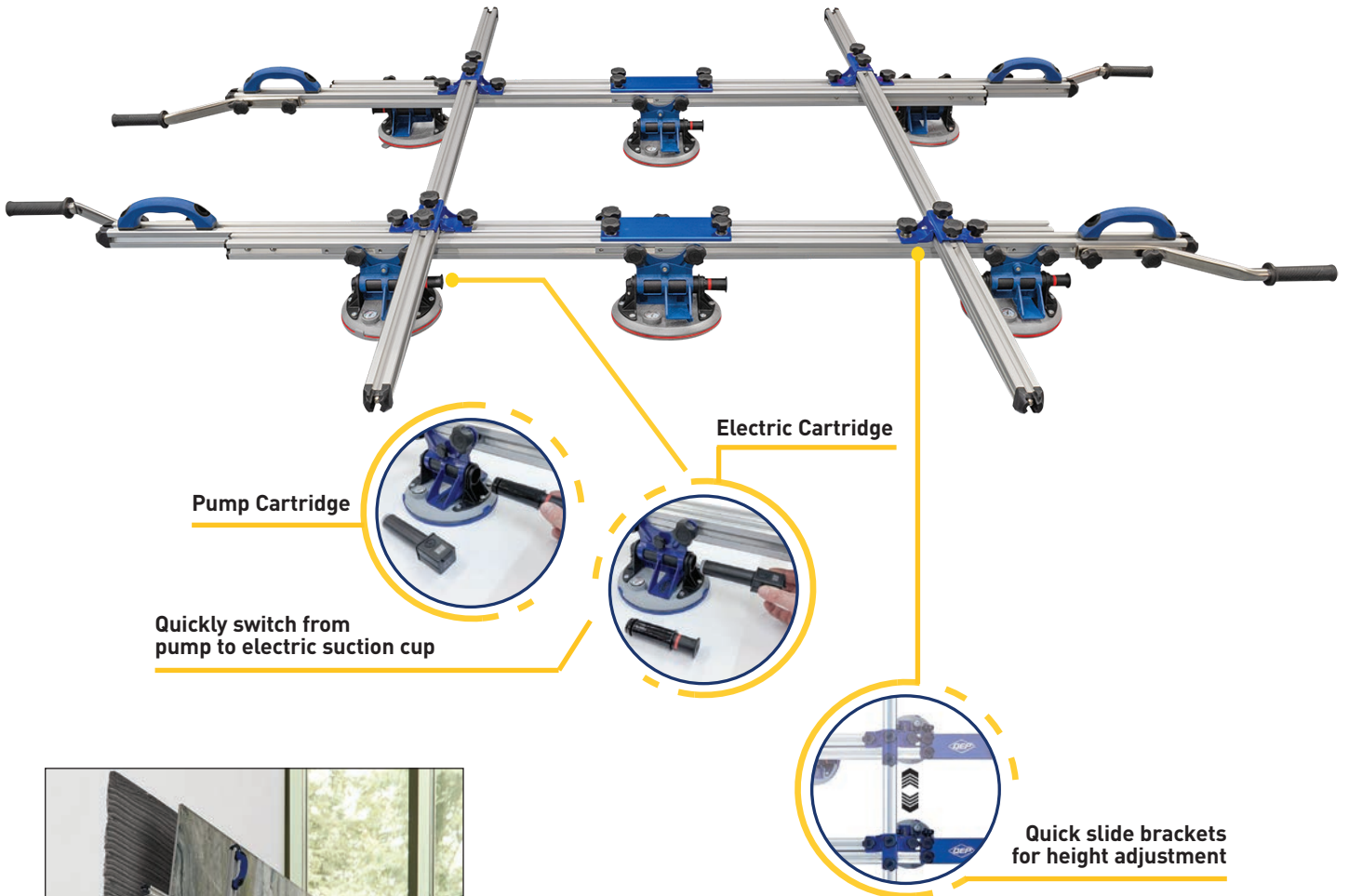

- Suitable to carry tile up to 10' x 5'
- Each suction cup can be easily removed and used individually holding up to 286 lbs. (130 kg) each
- 8" grey non-marring suction cups providing consistent suction on smooth and semi textured surfaces
- Four top fixed handles and four repositionable extension handles provide a firm grip for carrying tile
- Includes 2 lithium 21v 2.0Ah batteries and USB charging cable
- Includes a carry bag



Item No.	Description	Case Qty	Packaging
75028	GPTP™ Carrying System	1	Color Carton



SCAN HERE FOR MORE PRODUCT INFORMATION



# GPTP™ Transport Cart -60" H x 60" W x 32" D

Perfect solution for safely moving large tile panels

**NEW-AVAILABLE  
JUNE 2025**



- Heavy Duty Aluminum A-Frame holds panels up to 5' x 10'
- The cart easily folds in two pieces for easy storage
- Four 22" Extension arms add an extra 3-1/2" of support when transporting panels
- Two front stops prevent panels from sliding off the bottom
- Adjustable center cross bar provides support for smaller tiles
- Base support slats hold smaller pieces of cut tile
- 5" Non-marring rubber wheels with two front locking casters
- 24" top hook prevents panels from falling forward



Item No.	Description	Case Qty	Packaging
75029	GPTP™ Transport Cart	1	Carton



SCAN HERE FOR MORE PRODUCT INFORMATION

# GPTP™ Vibrating Suction Cup

The vibrations help seat tiles firmly into the thinset, drastically cutting down the time spent on each individual tile

**NEW-AVAILABLE  
OCTOBER 2025**



- Eliminates trapped air bubbles under tile
- Variable speed trigger control vibration
- Can be used on floor and wall tile
- Suction cup lifting power up to 77 lbs.
- Includes two 21V lithium batteries with charger



Item No.	Description	Case Qty	Packaging
75031	GPTP™ Vibrating Suction Cup	1	Color Carton



SCAN HERE FOR MORE PRODUCT INFORMATION



# TILE CUTTERS & SCORING WHEELS

QEP offers professional cutters for cutting tile, porcelain, mosaics and other materials. The QEP Katana Single Rail Tile cutters, multipurpose Big Clinkers, lightweight Slimline cutters and traditional cutters are engineered for the Pros by the Pros.

Designed to make cutting easy with features like side arm extensions, ball bearing slides and locking features, QEP puts quality and safety first.



# Katana™ SR-41 Tile Cutter

NEW-AVAILABLE  
MARCH 2025

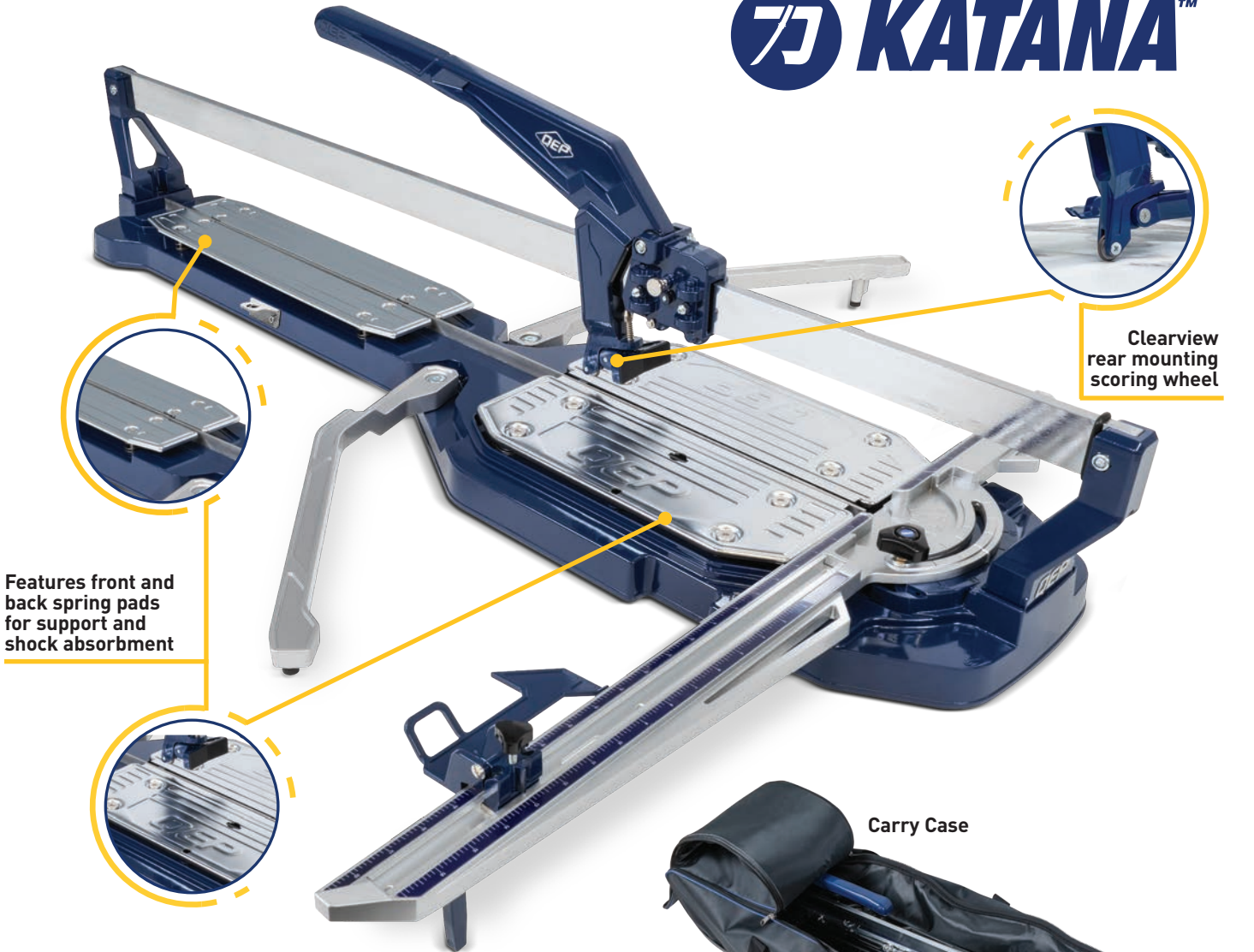

Features front and back spring pads for support and shock absorbment

Clearview rear mounting scoring wheel

Carry Case

- Smooth score chassis with 11 enclosed ball bearing rollers
- Clearview rear mounting scoring wheel with quick release breaker bar designed for precise cutting
- Heavy duty cast aluminum base with front and back steel spring plates
- Full length 20" side wing support arms prevent tile dipping
- Adjustable fence with positive stops at 22-1/2", 45 and 90°
- 20" Extended handle for maximum breaking power
- Fence is designed to fit and store by locking in place within the cutter
- Flip-up rip guide for straight or angled cuts
- Includes carry case for easy transport
- Includes Cutting wheel



**REPLACEMENT SCORING WHEEL:**  
21131 7/8" PREMIUM Titanium-Coated Tungsten Carbide Ball Bearing Scoring Wheel (6/cs)



**RIP CUT**  
10410: Up to 41" Tile



**DIAGONAL**  
10410: Up to 29" Tile



**TILE DEPTH**  
5/8" Max.

Item No.	Description	Case Qty	Packaging
10410	Katana SR-41 Tile Cutter	1	Carton



SCAN HERE FOR MORE PRODUCT INFORMATION

# Katana™ SR-31 Tile Cutter

NEW-AVAILABLE  
MARCH 2025



Clearview rear mounting scoring wheel

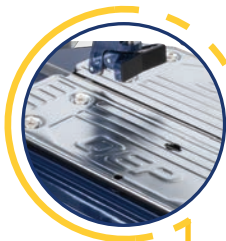

Features spring pads for support and shock absorbment

- Smooth score chassis with 11 enclosed ball bearing rollers
- Clearview rear mounting scoring wheel with quick release breaker bar designed for precise cutting
- Heavy duty cast aluminum base with front steel spring plate and rear premium rubber
- Full length 20" side wing support arms prevent tile dipping
- Adjustable fence with positive stops at 22-1/2, 45 and 90°
- 20" Extended handle for maximum breaking power
- Fence is designed to fit and store by locking in place within the cutter
- Flip-up rip guide for straight or angled cuts
- Includes Cutting wheel

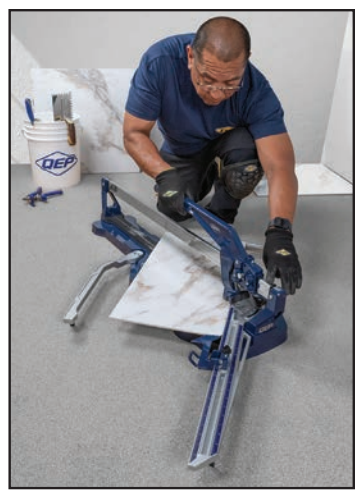

**REPLACEMENT SCORING WHEEL:**  
21131 7/8" PREMIUM Titanium-Coated Tungsten Carbide Ball Bearing Scoring Wheel (6/cs)



**RIP CUT**  
10310: Up to 31" Tile



**DIAGONAL**  
10310: Up to 22" Tile



**TILE DEPTH**  
5/8" Max.

Item No.	Description	Case Qty	Packaging
10310	Katana SR-31 Tile Cutter	1	Carton

SCAN HERE FOR MORE PRODUCT INFORMATION



\*\*Certain materials over 15mm thick can be challenging to cut manually due to their physical properties and potential tensions. It is advisable to conduct sample cuts to assess compatibility.



# Big Clinker Tile Cutter - 28", 25" & 22-1/2"

## BIG CLINKER



- Height adjustable 4-position wheel for easy snapping in any position on tile
- Equipped with replaceable 7/8" titanium-coated tungsten carbide ball bearing scoring wheel
- Side arm extensions to support large format tiles
- Durable chrome plated steel rails
- Rip/Angle guide for fast multiple cuts
- Heavy duty cast aluminum base
- Includes Cutting Wheel



Item No.	Description	Case Qty	Packaging
10800	28" Big Clinker Tile Cutter	1	Color Carton
10600	25" Big Clinker Tile Cutter	1	Color Carton
10500	22-1/2" Big Clinker Tile Cutter	1	Color Carton



**REPLACEMENT SCORING WHEEL:**  
 211230 7/8" PREMIUM  
 Titanium-Coated Tungsten Carbide  
 Ball Bearing Scoring Wheel  
 (6/cs)



**RIP CUT**  
 10800: Up to 28" Tile  
 10600: Up to 25" Tile  
 10500: Up to 22.5" Tile



**DIAGONAL**  
 10800: Up to 20" Tile  
 10600: Up to 18" Tile  
 10500: Up to 16" Tile



**TILE DEPTH**  
 10800: 5/8" Max.  
 10600: 5/8" Max.  
 10500: 5/8" Max.

SCAN HERE FOR MORE PRODUCT INFORMATION



# Slimline Cutters - 24", 30" and 36"

## SLIMLINE



**24  
INCH**

**30  
INCH**

**36  
INCH**



**Only 5-1/2" wide and lighter than standard cutters**

**5-1/2 inches**

- Lightweight and easy to carry from site to site
- Equipped with replaceable tungsten-carbide 7/8" scoring wheel
- Reinforced thick steel base with tile support arms
- Die cast aluminum rail supports
- Metal rip guide
- Includes Cutting wheel



Item No.	Description	Case Qty	Packaging
10624Q	24" Slimline Manual Tile Cutter, with 2 legs	1	Color Carton
10636Q	36" Slimline Manual Tile Cutter, with 4 legs	1	Color Carton
<b>QEP Canada Only</b>			
10632Q	30" Slimline Manual Tile Cutter, with 2 legs	1	Color Carton

**REPLACEMENT SCORING WHEEL:**  
21178 7/8" Titanium-Coated Tungsten Carbide Scoring Wheel (3/cs)

**RIP CUT**  
10624Q: Up to 24" Tile  
10632Q: Up to 30" Tile  
10636Q: Up to 36" Tile

**DIAGONAL**  
10624Q: Up to 18" Tile  
10632Q: Up to 21" Tile  
10636Q: Up to 25" Tile

**TILE DEPTH**  
1/2" Max.

SCAN HERE FOR MORE PRODUCT INFORMATION





# LFT Manual Tile Cutter - 48"

- Ball bearing cutting head for accurate and easy scoring
- Breaking System Lever produces max amount of pressure
- Locking slide to prevent damage in transport
- Locking swivel angle and measurement bar
- Dual breaker bar for narrow and wide tile
- Equipped with replaceable tungsten-carbide 7/8" scoring wheel
- Breaking pads are mounted on springs for better shock absorption
- Cut-out under breaking pads allows for tile cuttings to fall through for easy cleaning
- Includes Cutting wheel



Item No.	Description	Case Qty	Packaging
10480Q	48" LFT Manual Cutter	1	Color Carton

**REPLACEMENT SCORING WHEEL:**  
21178 7/8" Titanium-Coated Tungsten Carbide Scoring Wheel (3/cs)

**RIP CUT**  
10480Q: Up to 48" Tile

**DIAGONAL**  
10480Q: Up to 34" Tile

**TILE DEPTH**  
5/8" Max.



SCAN HERE FOR MORE PRODUCT INFORMATION

# Tile Cutters - 35" & 24"

- Ball bearing slide for smooth scoring
- Side arm extensions to support large format tiles
- Equipped with replaceable 7/8" titanium-coated tungsten carbide ball bearing scoring wheel
- Durable chrome plated steel rails
- Rip/Angle guide for fast multiple cuts
- Includes Cutting wheel



Item No.	Description	Case Qty	Packaging
10900	35" Tile Cutter	2	Color Carton
10630	24" Tile Cutter	1	Color Carton



35  
INCH

24  
INCH

**REPLACEMENT SCORING WHEEL:**  
21125 7/8" Titanium-Coated Tungsten Carbide Ball Bearing Scoring Wheel (6/cs)

**RIP CUT**  
10900: Up to 35" Tile  
10630: Up to 24" Tile

**DIAGONAL**  
10900: Up to 24" Tile  
10630: Up to 17.5" Tile

**TILE DEPTH**  
1/2" Max.

10900

10630



SCAN HERE FOR MORE PRODUCT INFORMATION

# Tile Cutter - 21"

- High leverage, padded handle makes cutting easier and reduces fatigue
- Durable chrome-plated solid steel rails for smooth scoring
- Powder coated steel base with extra center reinforcement
- Includes replaceable tungsten carbide 10 mm post scoring wheel

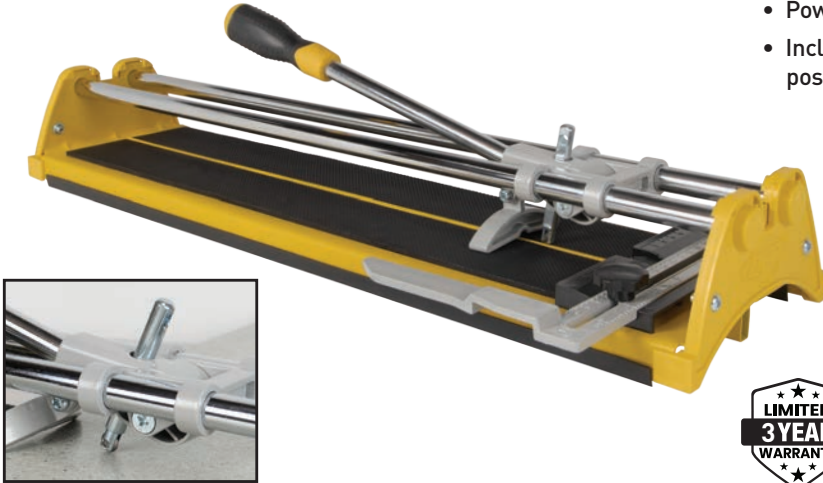

Item No.	Description	Case Qty	Packaging
10221Q	21" Tile Cutter	2	Color Carton



**REPLACEMENT SCORING WHEEL:**  
21127Q  
10 mm Post Scoring Wheel  
(6/cs)



**RIP CUT**

10221Q: Up to 21" Tile



**DIAGONAL**

10221Q: Up to 15" Tile



**TILE DEPTH**  
3/8" Max.

# Tile Cutters - 20" & 14"

- Equipped with replaceable 1/2" titanium-coated tungsten carbide scoring wheel
- Durable chrome-plated solid steel rails for smooth scoring
- Powder coated steel base with extra center reinforcement
- Includes Cutting wheel



Item No.	Description	Case Qty	Packaging
10220Q	20" Tile Cutter	4	Color Carton
10214Q	14" Tile Cutter	6	Color Carton



**REPLACEMENT SCORING WHEEL:**  
10010HD 1/2"  
Tungsten Carbide Scoring Wheel  
(12/cs)



**RIP CUT**

10220Q: Up to 20" Tile  
10214Q: Up to 14" Tile



**DIAGONAL**

10220Q: Up to 14" Tile  
10214Q: Up to 10" Tile



**TILE DEPTH**  
3/8" Max.



# Replacement Wheels for Tile Cutters

ITEM NO.	DESCRIPTION	21127Q 10 mm Wheel	10010HD 1/2" Wheel	21123Q 7/8" Wheel	21125 7/8" Wheel	21178 7/8" Wheel	21131 7/8" Wheel
10480Q	48" LFT Manual Tile Cutter					•	
10636Q	36" Slimline Tile Cutter					•	
10632Q	30" Slimline Tile Cutter					•	
10624Q	24" Slimline Cutter					•	
10900	35" Tile Cutter				•		
10800	28" Big Clinker Tile Cutter			•			
10630	24" Tile Cutter				•		
10600	24" Big Clinker Tile Cutter			•			
10221Q	21" Tile Cutter	•					
10500	22-1/2" Big Clinker Tile Cutter			•			
10220Q	20" Tile Cutter		•				
10214Q	14" Tile Cutter		•				
10310	SR-31 Katana Tile Cutter						•
10410	SR-41 Katana Tile Cutter						•

## 10 mm Post Scoring Wheel



- For cutting ceramic, porcelain and glass tiles
- Tungsten carbide scoring edge for long cutting life
- For use with 10221Q 21" Professional Tile Cutter

Item No.	Description	Case Qty	Packaging
21127Q	10 mm Post Scoring Wheel	6	Hang Card

## 1/2" Tungsten Carbide Scoring Wheel

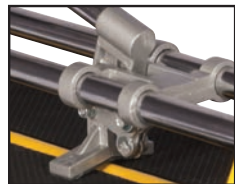

- For cutting ceramic, porcelain and glass tiles
- For use with 10220Q 20" QEP Tile Cutter and 10214Q 14" QEP Tile Cutter

Item No.	Description	Case Qty	Packaging
10010HD	1/2" Tungsten Carbide Scoring Wheel	12	Hang Card

## 7/8" Replacement Scoring Wheels with Ball Bearings

- For cutting ceramic, porcelain and glass tiles
- Ball bearing wheel for smooth scoring
- Designed to use with any tile cutters



- For use with:  
10800 28" Big Clinker Tile Cutter  
10600 24" Big Clinker Tile Cutter  
10500 22-1/2" Big Clinker Tile Cutter

- For use with:  
10900 35" Tile Cutter  
10603 24" Tile Cutter

- For use with:  
10480Q LFT Manual Tile Cutter  
10636Q 36" Slimline Tile Cutter  
10632Q 30" Slimline Tile Cutter  
10624Q 24" Slimline Tile Cutter

- For use with:  
10310 SR-31 Tile Cutter  
10410 SR-41 Tile Cutter

Item No.	Description	Case Qty	Packaging
21123Q	7/8" Premium Tile Cutter Replacement Scoring Wheel with Ball Bearings	6	Hang Card

Item No.	Description	Case Qty	Packaging
21125	7/8" Tile Cutter Replacement Scoring Wheel with Ball Bearings	6	Hang Card

Item No.	Description	Case Qty	Packaging
21178	7/8" Titanium Coated Replacement Scoring Wheel for Multiple Tile Types	3	Hang Card

Item No.	Description	Case Qty	Packaging
21131	7/8" Titanium Coated Replacement Scoring Wheel for Multiple Tile Types	6	Hang Card



## TILE SAWS & DIAMOND BLADES

QEP's line of award-winning Tile Saws for cutting large format ceramic, porcelain, granite, stone and marble tile are engineered by the pros for the pros. Designed with features such as splash guard water containment systems, extension tables and safety locks, QEP Tile Saws make work easier. Our Diamond Blade line assures smooth and precise cuts every time.



# RC40 Overhead Tile Saw - 10"

**NEW-AVAILABLE  
OCTOBER 2025**

Electric wet saw with fold-out stand for cutting large format tile including ceramic, porcelain, granite, and marble



- Rip Capacity 40", diagonal cutting capacity 28"
- Premium 10" Blade
- Comfort cutting height at 37"
- Drop down table fence for unlimited rips
- Rust resistant Stainless Steel durable rollers on table
- 4.3 gallon water tray
- 2.5 HP motor with soft start
- Separate switch to run water pump increases life of the motor

## ACCESSORIES INCLUDED

- 10" continuous rim wet diamond blade
- Angle cutting guide
- Pump
- Stand



## SPECIFICATIONS

Item No	60400
Motor	2.5 HP/120V~60 Hz./ 15 Amp
Watts	1750 W
RPM	5000
Blade Capacity	10"
Arbor	5/8"
Size	66" H x 43.5" W x 45.25" D
Weight	112 lbs.

\*Complies with Canadian and U.S. requirements

Item No.	Description	Case Qty	Packaging
60400	RC40 Overhead Tile Saw - 10" Blade	1	Color Carton



**SCAN HERE** FOR MORE PRODUCT INFORMATION

# RC24 Overhead Tile Saw - 7"

**NEW-AVAILABLE  
AUGUST 2025**

Portable electric wet saw with fold-out stand for cutting large format tile including ceramic, porcelain, granite, and marble



- Rip Capacity 24", diagonal cutting capacity 18"
- Premium 7" Blade
- Rust resistant durable nylon rollers on table
- 3 gallon water tray
- LED Laser light and adjustable laser for accurate setup
- 1.5 HP motor with soft start

## ACCESSORIES INCLUDED

- 7" continuous rim wet diamond blade
- Angle cutting guide
- Pump
- Stand



## SPECIFICATIONS

Item No	60240
Motor	1.5 HP/120 V ~ 60 Hz. / 10 Amp
Watts	1100 W
RPM	6000
Blade Capacity	7"
Arbor	5/8"
Size	20.8" H x 15.74" W x 9.88" D
Weight	64 lbs.

\*Complies with Canadian and U.S. requirements

Item No.	Description	Case Qty	Packaging
60240	RC24 Overhead Sliding Tile Saw - 7" Blade	1	Color Carton

SCAN HERE FOR MORE PRODUCT INFORMATION







# Power Pro 1HP Wet Tile Saw - 7"

Portable electric cutter for cutting porcelain tile, ceramic tile, marble, slate and stone

- 

**UNLIMITED  
STRAIGHT  
CUTS**
- 

**UNLIMITED  
DIAGONAL  
CUTS**
- 

**15°, 35° & 45°  
MITER CUTS**
- 

**1-1/8" MAX  
TILE DEPTH**



- Direct-drive, 1HP motor is quiet and delivers power to handle ceramic, slate, marble, granite and porcelain\*\*
- Water catch system reduces water run off and recycles water back into the reservoir minimizing fill frequencies
- Large die-cast aluminum cutting table for precision 15°, 30° and 45° miter cuts
- Adjustable rip and sliding angle guides for accurate production cuts
- Lock on/off switch with key provides additional safety
- Tested and Compliant - Exceeds OSHA Silica Rule 29 CFR 1926.1153

## ACCESSORIES INCLUDED

- 7" continuous rim wet diamond blade
- Locking rip guide
- Angle cutting guide
- Folding bench stop



## SPECIFICATIONS

Item No	22900Q
Motor	1 HP / 120 V ~ 60 Hz. / 6.5 Amps
Watts	750
RPM	3600
Blade Capacity	7"
Arbor	5/8"
Size	22.5" L x 18" W x 8" H
Weight	29 lbs

\*Complies with Canadian and U.S. requirements

Item No.	Description	Case Qty	Packaging
22900Q	7" Power Pro 1HP Wet Tile Saw	1	Color Carton

\*\*for porcelain and hard tile we recommend QEP's Black Widow Blade (6-7008BW)

SCAN HERE FOR MORE PRODUCT INFORMATION



# 750XT Wet Tile Saw - 7"

Portable electric cutter for cutting porcelain tile, ceramic tile, marble, slate and stone

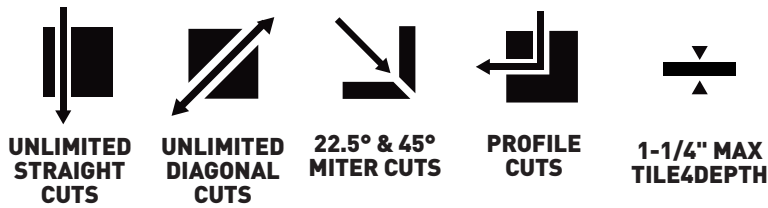

- Direct-drive, 3/4 Peak motor is quiet and delivers power to handle ceramic, slate, marble, granite and porcelain\*\*
- Water catch system reduces water run-off and recycles water back into the reservoir minimizing fill frequencies
- Back extension table to support large format tiles
- Tilt-up cutting table for precision 22.5° and 45° miter cuts
- Adjustable rip and sliding angle guides for accurate production cuts
- Tested and Compliant - Exceeds OSHA Silica Rule 29 CFR 1926.115

## ACCESSORIES INCLUDED

- 7" continuous rim wet diamond blade
- Locking rip guide
- Angle cutting guide
- Universal wrench



## SPECIFICATIONS

Item No	22750Q
Motor	3/4-Peak HP/120 V ~ 60 Hz. / 4.8 Amps
Watts	550
RPM	3600
Blade Capacity	7"
Arbor	5/8"
Size	21" L x 22.2" W x 9.5" H
Weight	21.4 lbs

\*Complies with Canadian and U.S. requirements

Item No.	Description	Case Qty	Packaging
22750Q	7" 750XT Wet Tile Saw	1	Color Carton

\*\*for porcelain and hard tile we recommend QEP's Black Widow Blade (6-7008BW)





SCAN HERE FOR MORE PRODUCT INFORMATION





# 700XT Wet Tile Saw -7"

Portable electric wet saw for cutting ceramic, slate, marble, granite and porcelain

-   
**UNLIMITED STRAIGHT CUTS**
-   
**UNLIMITED DIAGONAL CUTS**
-   
**PROFILE CUTS**
-   
**22.5° & 45° MITER CUTS**
-   
**1-1/4" MAX TILE DEPTH**



- Direct-drive, 3/4 Peak HP motor is quiet and powerful to handle ceramic, slate, marble, granite and porcelain
- Water catch system reduces water run-off and recycles water back into the reservoir minimizing fill frequencies
- Adjustable rip and sliding angle guides for accurate production cuts
- 8" Extension side table to support large tile

## ACCESSORIES INCLUDED

- 7" continuous rim wet diamond blade
- Locking rip guide
- Angle cutting guide
- Blade wrench



## SPECIFICATIONS

Item No	22700Q
Motor	3/4-Peak HP/120 V ~ 60 Hz. / 4.8 Amps
Watts	550
RPM	3600
Blade Capacity	7"
Arbor	5/8"
Size	20.08" L x 15.74" W x 9.88" H
Weight	23 lbs

\*Complies with Canadian and U.S. requirements

Item No.	Description	Case Qty	Packaging
22700Q	7" 700XT Tile Wet Saw	1	Color Carton

SCAN HERE FOR MORE PRODUCT INFORMATION



# Torque Master XT Portable Wet Tile Saw - 4"

Portable electric cutter for cutting porcelain tile, ceramic tile, marble, slate and stone

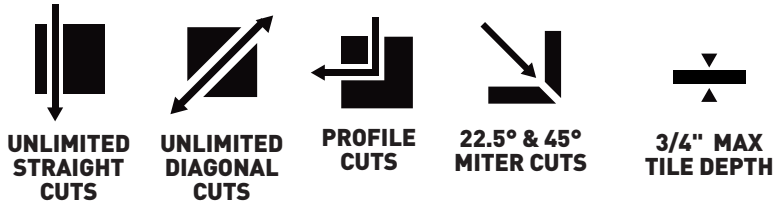

- Direct-drive, 3/5 HP motor is quiet and delivers power to handle ceramic, slate, marble, granite and porcelain
- Water catch system reduces water run-off and recycles water back into the reservoir minimizing fill frequencies
- Fully adjustable miter guide with unique ratchet mechanism
- 2 side extension tables that add 5" of cutting surface

## ACCESSORIES INCLUDED

- 4" continuous rim diamond blade (#6-4003Q)
- 45° angle guide
- Blade guard



## SPECIFICATIONS

Item No	22400Q
Motor	3/5 HP / 120 V ~ 60 Hz. / 4 Amps
Watts	450
RPM	4600
Blade Capacity	4"
Arbor	5/8"
Size	14.3" L x 15.8" W x 4.6" H
Weight	8 lbs

\*Complies with Canadian and U.S. requirements

Item No.	Description	Case Qty	Packaging
22400Q	4" Torque Master XT Portable Wet Tile Saw	1	Color Carton

SCAN HERE FOR MORE PRODUCT INFORMATION





# Tile Saws at a glance

## Professional Wet Saws

ITEM NO.	DESCRIPTION	WEIGHT (lbs)	BLADE	HP	RPM	RIP CUT (Tile Size)	DIAGONAL (Tile Size)	CUTTING DEPTH
60400	10" RC40 Overhead Tile Saw	112	10"	2.5	5000	Unlimited	28"	2-3/4"
60240	7" RC24 Overhead Sliding Tile Saw	22.55	7"	1.5	6000	24"	18"	2-1/4"

## Professional Table Saws

ITEM NO.	DESCRIPTION	WEIGHT (lbs)	BLADE	HP	RPM	RIP CUT (Tile Size)	DIAGONAL (Tile Size)	CUTTING DEPTH
22900Q	7" Power Pro Wet Tile Saw	29	7"	1	3600	Unlimited	Unlimited	1-1/8"
22750Q	7" 750XT Wet Tile Saw	21.4	7"	3/4	3600	Unlimited	Unlimited	1-1/4"
22700Q	7" 700XT Wet Tile Saw	23	7"	3/4	3600	Unlimited	Unlimited	1-1/4"
22400Q	4" Torque Master XT Portable Tile Saw	8	4"	3/5	4600	Unlimited	Unlimited	1/4"

# Black Widow® Blades

The QEP Black Widow® Premium-Grade, thin-rim Diamond Blades quickly cut through the toughest ceramic, porcelain, marble and granite. Independent lab test results have proven Black Widow® Blades continuously out perform the competition in durability. QEP blades are designed to use with any tile saws.



- Premium-grade, thin-rim diamond blade for fast wet cutting of porcelain, ceramic, granite and marble tile
- Ideal for high speed cutting of hard masonry tile
- Unique diamond-shaped laser cutouts prevent blade wobble and keep blade cooler for a longer life
- 7 mm rim height for a longer life and for increased cutting contact with the blade



Item No.	Description	Application	Rim Height	Width	Arbor Size	Max RPM	No. in Case	Package
6-4008BW	4" Black Widow®	Ceramic, Porcelain, Marble, Granite - Wet/Dry	7 mm	.060	5/8" - 20 mm - 7/8"	15000	5	Hang Card
6-7008BW	7" Black Widow®	Ceramic, Porcelain, Marble, Granite - Wet	7 mm	.060	5/8"	8730	5	Hang Card
6-8008BW	8" Black Widow®	Ceramic, Porcelain, Marble, Granite - Wet	7 mm	.060	5/8"	7640	5	Hang Card
6-1008BW	10" Black Widow®	Ceramic, Porcelain, Marble, Granite - Wet	7 mm	.060	5/8"	6115	5	Hang Card

▲WARNING: Cancer and Reproductive Harm- www.P65Warnings.ca.gov. See P. 89, \*Prop 65 - 1.

# Diamond Blades

The QEP diamond blade line offers a blade for every application and budget. Whether your tile project requires the cutting of ceramic, porcelain, marble, granite, glass, slate, concrete pavers or stone, QEP has a blade that will cut it quickly and efficiently. QEP blades are designed to use with any tile saws.



## Black Series General purpose blade for wet cutting of ceramic tile.

Item No.	Description	Rim Height	Width	Arbor Size	Max RPM	No. in Case	Package
6-4001Q	4" Continuous Rim	7 mm	.060	5/8" - 20 mm - 7/8"	15000	4	Hang Card
6-7001Q	7" Continuous Rim	7 mm	.060	5/8" - DM	8730	4	Hang Card
6-8001Q	8" Continuous Rim	7 mm	.060	5/8" - DM	7640	4	Hang Card
6-1001Q	10" Continuous Rim	7 mm	.060	5/8" - DM	6115	4	Hang Card



## Gold Series Premium blade for wet or dry\* cutting of ceramic, porcelain and marble tile.

Item No.	Description	Rim Height	Width	Arbor Size	Max RPM	No. in Case	Package
6-4003Q	4" Continuous Rim	7 mm	.060	5/8" - 20 mm - 7/8"	15000	4	Hang Card
6-7003Q	7" Continuous Rim	7 mm	.060	5/8"	8730	4	Hang Card
6-8003Q	8" Continuous Rim	7 mm	.060	5/8"	7640	4	Hang Card
6-1003Q	10" Continuous Rim	7 mm	.060	5/8"	6115	4	Hang Card

\*4" can be used for wet/dry cutting, other sizes are for wet cutting only.



## Glass Series Premium blade for wet cutting of glass tile.

Item No.	Description	Rim Height	Width	Arbor Size	Max RPM	No. in Case	Package
6-4006GLQ	4" Continuous Rim	7 mm	.060	5/8" - 20 mm - 7/8"	15000	3	Hang Card
6-7007GL	7" Continuous Rim	7 mm	.060	5/8"	8730	3	Hang Card

⚠ WARNING: Cancer and Reproductive Harm - www.P65Warnings.ca.gov. See P. 89, \*Prop 65 - 1.





# TILE LEVELING SYSTEM

QEP offers a variety of systems and spacer styles to eliminate tile lippage.

LASH® XL Tile Leveling System ,The original LASH® Tile Leveling System and LASH® 360 Tile Leveling System are two-part systems to eliminate uneven tiles.

Our horseshoe shims, flexible tile spacers, hard tile spacers, and “T” tile spacers are all solid options for aligning floor and wall tile based on your installation preferences.

# Tile Leveling System

The **ORIGINAL**  
**LASH**<sup>®</sup>  
LEVEL ALIGN SPACE HOLD

## The World's Best Tile Leveling System

The Original LASH<sup>®</sup> Tile Leveling System is designed for quick installation and reduces costly call backs by ensuring that the finished floor surface is lippage-free. This time-saving system helps adjust the height of the tiles and evenly holds their edges throughout the curing process of the setting material.

### Two-part system eliminates uneven tile - Clips and Wedges

- For tile between 1/4" and 7/16" thick
- Proprietary poly blend for secure holding and easy break off
- Clips provide 1/16" or 1/8" grout widths
- May be combined with regular tile spacers for wider joints - up to 1/4"
- Wedges are reusable

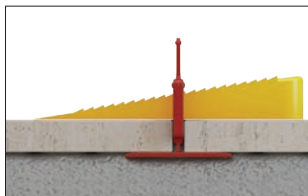
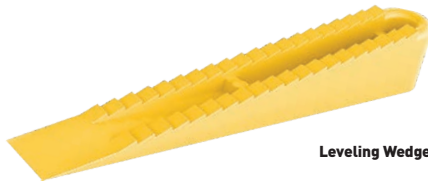
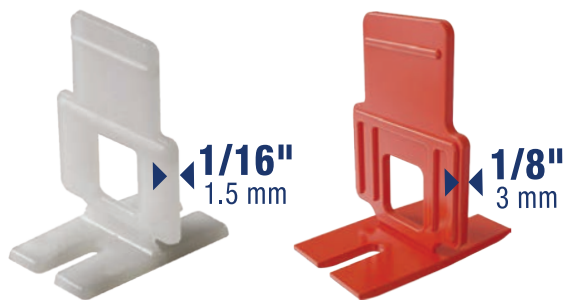

LASH<sup>®</sup> Flat Clip for Floor and Wall Tiles



Item No.	Description	Qty	Case Qty	Packaging
99730	1/16" LASH <sup>®</sup> Clips, Bag	100	8	Shelf Case
99731	1/16" LASH <sup>®</sup> Clips, Box	300	4	Shelf Case
<b>NEW</b> 99790	1/16" LASH <sup>®</sup> Clips, Box	500	1	Shelf Case
99740	1/16" LASH <sup>®</sup> Clips, Box	1000	1	Color Box
<b>NEW</b> 99792	1/16" LASH <sup>®</sup> Clips, Box	2000	1	Color Box
99707Q	1/16" LASH <sup>®</sup> Clips, Box	4800	1	Contractor Pack
99781	1/8" LASH <sup>®</sup> Clips, Bag	100	8	Shelf Case
99782	1/8" LASH <sup>®</sup> Clip, Box	300	4	Shelf Case
<b>NEW</b> 99791	1/8" LASH <sup>®</sup> Clips, Box	500	1	Shelf Case
99783	1/8" LASH <sup>®</sup> Clips, Box	1000	1	Color Box
<b>NEW</b> 99793	1/8" LASH <sup>®</sup> Clips, Box	2000	1	Color Box
99726	LASH <sup>®</sup> Wedges, Bag	100	8	Shelf Case
99727	LASH <sup>®</sup> Wedges, Bag	300	4	Shelf Case
99728	LASH <sup>®</sup> Wedges, 500PK/4CS	500	4	Shelf Case
99703	LASH <sup>®</sup> Wedges, Box	3600	1	Contractor Pack



SCAN HERE FOR MORE PRODUCT INFO

## Pro Installation Pliers

For faster installation use QEP Pro Installation Pliers

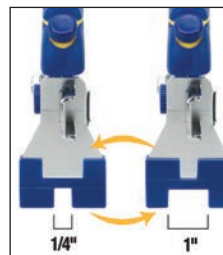

- Easily sets the wedge into the clip, and comfortably applies the right amount of pressure without overtightening
- Use with Original LASH<sup>®</sup> as well as LASH XL<sup>™</sup> Tile Leveling Systems for faster installation
- Stop pin regulates proper pressure at all times
- Co-molded plastic handle with non-slip, rubber grip for comfortable repeat use

Item No.	Description	Case Qty	Packaging
99784	Pro Installation Pliers	6	Hang Card



# LASH XL™ Tile Leveling System

**NEW**



- For tile up to 1/2" thick
- Proprietary poly blend for secure holding and easy break off
- Clips provide 1/32", 1/16", 1/8" and 3/16" grout widths
- Easy to use, especially with large format tile
- Wide clips and angled wedge are comfortable and prevent hand fatigue
- Wedges are reusable

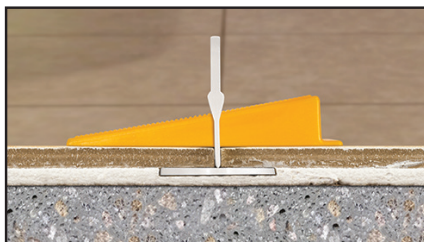
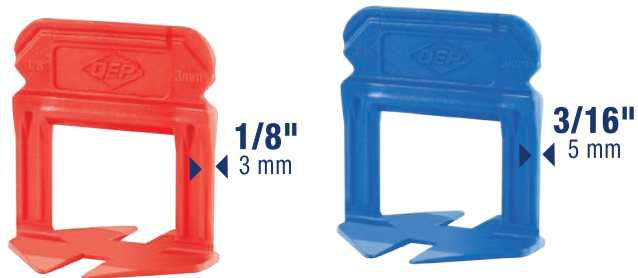

## Two- Part System eliminates uneven tile – Clips and Wedges

Lash XL ensures large format tile up to 1/2" thick are leveled and consistently spaced during installation. The Wedges are used in conjunction with the Leveling Clips to produce even grout lines and align neighboring tile delivering a lippage-free surface. For quick and easy removal, Clips are designed to break off below the surface of the tile with a simple kick in the direction of the grout line, or strike of a rubber head mallet.

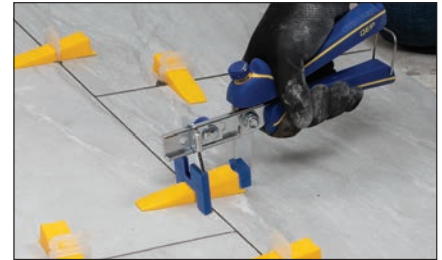

For faster installation use QEP Pro Installation Pliers. See page 31 for details.



Item No.	Description	Qty	Case Qty	Packaging
99751	LASH XL™ 1/32" Leveling Clips, Bag	100	8	Shelf Case
99971	LASH XL™ 1/32" Leveling Clips, Box	300	1	Color Box
99771	LASH XL™ 1/32" Leveling Clips, Box	500	1	Color Box
99871	LASH XL™ 1/32" Leveling Clips, Box	1000	1	Color Box
99776	LASH XL™ 1/32" Leveling Clips, Box	2000	1	Color Box
99761	LASH XL™ 1/16" Leveling Clips, Bag	100	8	Shelf Case
99861	LASH XL™ 1/16" Leveling Clips, Box	300	1	Color Box
99772	LASH XL™ 1/16" Leveling Clips, Box	500	1	Color Box
99872	LASH XL™ 1/16" Leveling Clips, Box	1000	1	Color Box
99777	LASH XL™ 1/16" Leveling Clips, Box	2000	1	Color Box
99769	LASH XL™ 1/8" Leveling Clips, Bag	100	8	Shelf Case
99869	LASH XL™ 1/8" Leveling Clips, Box	300	1	Color Box
99773	LASH XL™ 1/8" Leveling Clips, Box	500	1	Color Box
99873	LASH XL™ 1/8" Leveling Clips, Box	1000	1	Color Box
99778	LASH XL™ 1/8" Leveling Clips, Box	2000	1	Color Box
99763	LASH XL™ 3/16" Leveling Clips, Bag	100	8	Shelf Case
99774	LASH XL™ 3/16" Leveling Clips, Box	500	1	Color Box
99779	LASH XL™ 3/16" Leveling Clips, Box	2000	1	Color Box
99762	LASH XL™ Leveling Wedges, Bag	100	8	Shelf Case
99862	LASH XL™ Leveling Wedges, Box	300	1	Color Box
99775	LASH XL™ Leveling Wedges, Box	500	1	Color Box
99874	LASH XL™ Leveling Wedges, Box	1000	1	Color Box



SCAN HERE FOR MORE PRODUCT VIDEO

# LASH® 360 Tile Leveling System

## LASH® 360

LEVEL ALIGN SPACE HOLD

- For tile or pavers up to 3/4" thick
- Posts provide 1/32", 1/16", 1/8" and 3/16" grout widths
- Save time while providing a level and consistently spaced wall or floor
- Cap design makes it easy to spin on post and tighten with wings to level tile

### Two- Part Spin System eliminates uneven tile –Post and Caps- No tools required

LASH 360 ensures large format porcelain, ceramic and all natural stone tile up to 3/4" are leveled and consistently spaced during installation. The Caps are used in conjunction with the Posts to produce even grout lines and align neighboring tile delivering a lippage-free surface. For quick and easy removal, Posts are designed to break off below the surface of the tile with a simple kick in the direction of the grout line.



	Item No.	Description	Qty	Case Qty	Packaging
	99734	LASH® 360 Caps, Bag	100	4	Shelf Case
<b>NEW</b>	99834	LASH® 360 Caps, Box	300	4	Shelf Case
<b>NEW</b>	99838	1/32" LASH® 360 In-line, Box	1000	1	Color Box
	99735	1/16" LASH® 360 In-line, Bag	100	10	Shelf Case
<b>NEW</b>	99835	1/16" LASH® 360 In-line, Box	300	4	Shelf Case
<b>NEW</b>	99837	1/16" LASH® 360 In-line, Box	1000	1	Color Box
<b>NEW</b>	99839	1/8" LASH® 360 In-line, Box	1000	1	Color Box
<b>NEW</b>	99840	3/16" LASH® 360 In-line, Box	1000	1	Color Box

SCAN HERE FOR PRODUCT VIDEO





# Horseshoe Shims



1/16"  
1.5 mm



1/8"  
3 mm



3/16"  
5 mm



1/4"  
6 mm

- Ideal for marble, granite, stone, large format tiles and vertical installations.
- Allows user to lift both corners and align the joints from tile to tile
- Non-compressive

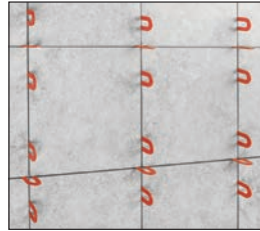

Packaged in reusable storage container

Item No.	Description	Case Qty	Packaging
10320	1/16" Horseshoe Shims - 200 Qty	6	Tub
10321	1/8" Horseshoe Shims - 150 Qty	6	Tub
10322	3/16" Horseshoe Shims - 100 Qty	6	Tub
10323	1/4" Horseshoe Shims - 75 Qty	6	Tub

# Hard Wedge Tile Spacers

**NEW**



3/16"  
5 mm



- Ideal for wall tile installation
- Perfect for back-splash installations
- Aligns tiles in vertical installations keeping grout lines even
- Made with a high density polymer that eliminates compression

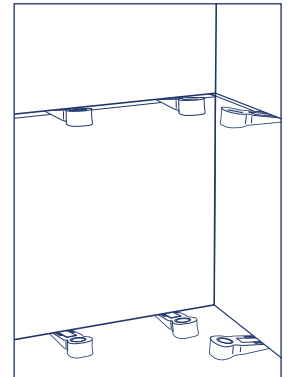

Packaged in reusable storage container

Item No.	Description	Case Qty	Packaging
10348	Hard Wedge Tile Spacer 3/16", Jar - 500 Qty	12	Jar

# Soft Wedge Tile Spacers



1/8"  
3 mm



- Crucial for achieving a level first row of wall tile
- Ideal for maintaining level horizontal grout lines during installation
- Avoids tile slippage on vertical surfaces - will not compress
- Can be used for up to 1/8" (3 mm)



Item No.	Description	Case Qty	Packaging
10285	Soft Wedge Tile Spacers 1/8", Bag - 500 Qty	16	Hang Card Shelf Case

# Traditional, Flexible Tile Spacers

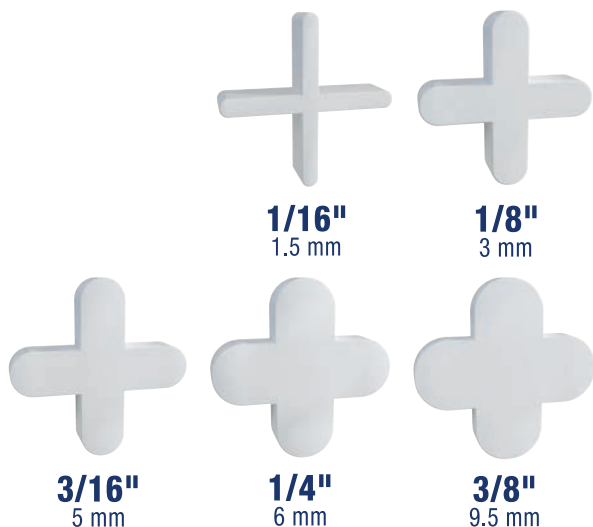

- Works with ceramic tile, porcelain, stone and marble
- Flexible, soft plastic design for easy maneuvering in tile joints
- Evenly space tiles for uniform grout lines
- For easy removal, use spacers vertically in traditional tombstone-style



Item No.	Description	Case Qty	Packaging
10334	1/16" Tile Spacers, Bag - 300 Qty	24	Shelf Case
10335	1/8" Tile Spacers, Bag - 500 Qty	14	Shelf Case
10336	3/16" Tile Spacers, Bag - 300 Qty	14	Shelf Case
10005	1/4" Tile Spacers, Bag - 200 Qty	15	Shelf Case
10027	3/8" Tile Spacers, Bag - 100 Qty	20	Shelf Case

**\*Not recommended for large format wall tiles over 15"**

# "T" Tile Spacers



- For aligning all floor and wall tiles
- For Subway, brick layout or offset tiling patterns and perimeters
- Will not compress when setting marble, granite, stone and large format tile
- Use in traditional "tombstone" style or leave between tiles and grout over
- Support bar and extended solid tip for improved tile support, keeping the spacer from compressing
- Longer leg length for easier installation

Item No.	Description	Case Qty	Packaging
10202	1/16" "T" Tile Spacers, Bag - 300 Qty	24	Hang Card/Shelf Case
10203	1/8" "T" Tile Spacers, Bag - 300 Qty	20	Hang Card/Shelf Case
10204	3/16" "T" Tile Spacers, Bag - 200 Qty	14	Hang Card/Shelf Case

# Hard, Leave-in Tile Spacers

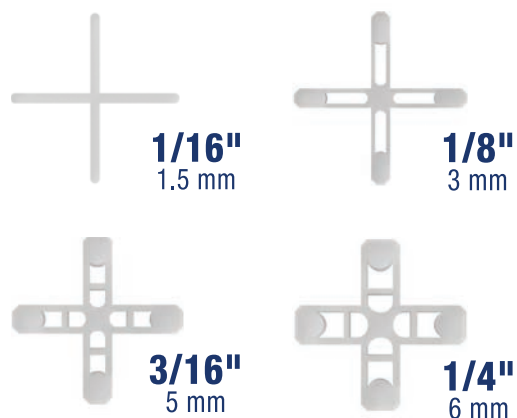

- Will not compress when setting marble, granite, stone and large format tile
- Use as traditional vertical tombstone-style or inset leave-in installation method
- Leave-In design reduces installation time
- Easy to handle, extra long prongs assure perfect 90° grout corners

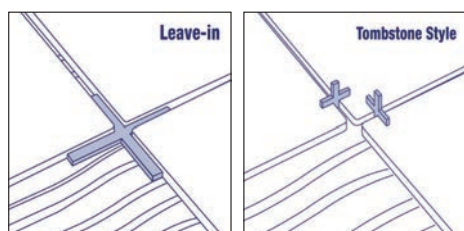

Item No.	Description	Case Qty	Packaging
10330-20	1/16" Leave-In Spacers, Bag - 300 Qty	20	Shelf Case
10331-18	1/8" Leave-In Spacers, Bag - 300 Qty	18	Shelf Case
10332	3/16" Leave-In Spacers, Bag - 200 Qty	12	Shelf Case
10333	1/4" Leave-In Spacers, Bag - 200 Qty	10	Shelf Case
10324	1/16" Leave-In Spacers, Jar - 1500 Qty	6	Shelf Case
10325	1/8" Leave-In Spacers, Jar - 1000 Qty	6	Shelf Case
10326	3/16" Tile Spacers, Jar - 500 Qty	6	Shelf Case





## TROWELS & FLOATS

QEP boasts an extensive offering of Trowels and Floats. With a variety of grips, sizes and designs, QEP makes it easy to find the right products for your tile installation project. Favorites of professional installers include the QEP Xtreme Pro Series Cork Handle Notched Trowels, QEP Margin Trowels and Floats, which feature bucket hooks for easy storage, and the QEP Extreme Pro Series Stone Grout Float, shaped to contour and flex giving you the leverage you need.





# EURO NOTCH TROWEL



Uniquely alternating notch pattern provides more consistent mortar bed by reducing voids

The best EURO NOTCH trowel in the industry





# XTREME<sup>™</sup> PRO-SERIES Cork Handle Stainless Steel Trowels



- Cork comfort grip for better cushion and anti-slippage in the hand
- 25% longer shank with 13 exposed, reinforced rivets for superior strength
- Extra handle-to-shank distance allows maximum hand clearance
- Rust resistant 12" x 4-1/2" durable stainless steel blade lasts 25% longer

	Item No.	Description	Case Qty	Packaging
<b>NEW</b>	49956-12	Xtreme Cork Handle Trowel Euro Notch (available in Canada)	12	Shelf Case
	49950-12	Xtreme Cork Handle Trowel Square Notch 1/4" x 1/4" x 1/4"	12	Shelf Case
	49951-12	Xtreme Cork Handle Trowel Square Notch 1/4" x 3/8" x 1/4"	12	Shelf Case
	49952-12	Xtreme Cork Handle Trowel Square Notch 1/2" x 1/2" x 1/2"	12	Shelf Case
<b>QEP Canada Only</b>				
	49953-12	Xtreme Cork Handle Trowel with ruler Square Notch 1/4" x 1/4" x 1/4"	12	Shelf Case
	49954-12	Xtreme Cork Handle Trowel with ruler Square Notch 1/4" x 3/8" x 1/4"	12	Shelf Case
	49955-12	Xtreme Cork Handle Trowel with ruler Square Notch 1/2" x 1/2" x 1/2"	12	Shelf Case

\*3rd Party independent testing performed by CARTA

# Comfort Grip Stainless Steel Trowels



- Large, contoured and cushioned grip handles for comfort
- Nine-rivet shank with reinforced end rivets for enhanced durability
- Extra handle-to-shank distance allows maximum hand clearance
- Rust resistant 11" x 4-1/2" durable stainless steel blade lasts 25% longer

	Item No.	Description	Case Qty	Packaging
<b>NEW</b>	49918-12	Comfort Grip Stainless Steel Trowel Euro Notch (available in Canada)	12	Shelf Case
	49915-12	Comfort Grip Stainless Steel Trowel Square Notch 1/4" x 1/4" x 1/4"	12	Shelf Case
	49916-12	Comfort Grip Stainless Steel Trowel Square Notch 1/4" x 3/8" x 1/4"	12	Shelf Case
	49917-12	Comfort Grip Stainless Steel Trowel V Notch 3/16" x 5/32"	12	Shelf Case
	49919-12	Comfort Grip Stainless Steel Trowel Square Notch 1/2" x 1/2" x 1/2"	12	Shelf Case

\*3rd Party independent testing performed by CARTA

# Wood Handle Trowels

- Quality 11" x 4-1/2" trowel designed for the professional installer
- Large wooden handle for an easy grip
- Hardened and tempered steel blade, ground and polished or long lasting durability
- Aluminum die-cast shank



	Item No.	Description	Case Qty	Packaging
	49713	Wood Handle Trowel Square Notch 1/4" x 1/4" x 1/4"	12	Shelf Case
	49714	Wood Handle Trowel Square Notch 1/4" x 3/8" x 1/4"	12	Shelf Case
	49716	Wood Handle Trowel V Notch 1/4" x 3/16"	12	Shelf Case
	49720	Wood Handle Trowel Square Notch 1/2" x 1/2" x 1/2"	12	Shelf Case

# Notched Trowels at a glance

Notch Size	Application	X-TREME Cork Handle (12" Blade)	Comfort Grip (11" Blade)	Wood Handle (11" Blade)	Standard (9" Blade)
3/16" x 5/32" V	For plastic, wall, ceramic & metal tile 6" x 6" or smaller and mosaics on drywall. Also for wall base.		49917-12		10115
1/4" x 3/16" V	For ceramic, metal & aluminum wall tile 6" x 6" up to 12" x 12"			49716	10116 Canada Only
1/4" x 1/4" x 1/4" SQ	For thinset application of ceramic tile 8" x 8" or smaller, laminated wood plank flooring, flat milled solid & shorts or plywood	49950-12 49953-12 Canada Only	49915-12	49713	10113
1/4" x 3/8" x 1/4" SQ	Thinset application of ceramic tile 8" x 8" up to 16" x 16"	49951-12 49954-12 Canada Only	49916-12	49714	10114
1/2" x 1/2" x 1/2" SQ	Thinset or medium bed mortar application of natural stone, quarry tile, pavers, saltillo and ceramic tiles 12" x 12" and larger	49952-12 49955-12 Canada Only	49919-12	49720	10120
1/2" x 1/32" x 3/8" x 1/4" x 1/2"	Thinset or medium bed mortar application of natural stone, quarry tile, pavers, saltillo and ceramic tiles 12" x 12" or larger.	49956-12	49918-12		

Always check adhesive/mortar manufacturer's trowel recommendations before selecting a trowel notch.

All Trowels Measure:

Width x Depth x Space Apart

Recommended notch sizes by NTCA  
(National Tile Contractors Association)

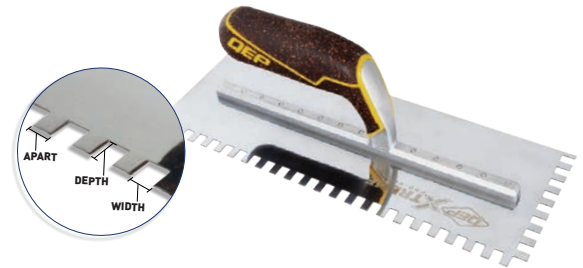

# Standard Trowels



- Quality trowel measuring 9" x 4"
- Hard, cold-rolled steel blade for longer wear
- High-impact black plastic handle



Item No.	Description	Case Qty	Packaging
10113	Standard Trowel Square Notch 1/4" x 1/4" x 1/4"	30	Shelf Case
10114	Standard Trowel Square Notch 1/4" x 3/8" x 1/4"	30	Shelf Case
10115	Standard Trowel V Notch 3/16" x 5/32"	30	Shelf Case
10120	Standard Trowel Square Notch 1/2" x 1/2" x 1/2"	30	Shelf Case
<b>QEP Canada Only</b>			
10116	Standard Trowel V Notch 1/4" x 3/16"	30	Shelf Case

# Patch & Finishing Trowel



- For leveling, patching and finishing
- Hardened, tempered, ground and polished steel blade
- Die-cast aluminum shank with wood handle

Item No.	Description	Case Qty	Packaging
49708	Patch & Finishing Trowel 11" x 4-1/2" No Notch	12	Shelf Case



# Margin Trowel



## BUCKET HOOK



- Enlarged 6" x 2" blade is made from ground, tempered and hardened steel for flexibility and durability
- Patent pending bucket hook for easy storage on the side of your bucket
- Co-molded plastic handle with non-slip, rubber grip for comfortable repeat use

Item No.	Description	Case Qty	Packaging
42112	6" x 2" Comfort Grip Margin Trowel No Notch	12	Shelf Case
42114	6" x 2" Comfort Grip Margin Trowel Square Notch 1/4" x 1/4" x 1/4"	12	Shelf Case

# Bucket Scoop



ARCHED SCOOP WITH FLAT SIDES GETS TO BOTTOM OF BUCKET

## BUCKET HOOK



- New Design! Scoops all setting material from sides and bottom of 4 or 5 gallon bucket
- Patent pending bucket hook for easy storage on the side of your bucket
- Improved contoured cushion handle provides better angle and flexibility
- Stainless steel blade

Item No.	Description	Case Qty	Packaging
42113-6	Bucket Scoop	6	Hang Card

# Margin Float



## BUCKET HOOK



- Ideal for hard-to-reach areas such as kitchen backsplashes or under bath and kitchen counters
- Patent pending bucket hook for easy storage on the side of your bucket
- Enlarged 6" x 2" gum rubber pad with tempered and hardened steel backing plate
- Co-molded plastic handle with non-slip, rubber grip

Item No.	Description	Case Qty	Packaging
42117	6" Comfort Grip Margin Float	12	Shelf Case

# **X-TREME** Stone Grout Float

For all grout types, including epoxy



**PRECISION ROUND CORNERS**  
Prevent gouging of grout joints

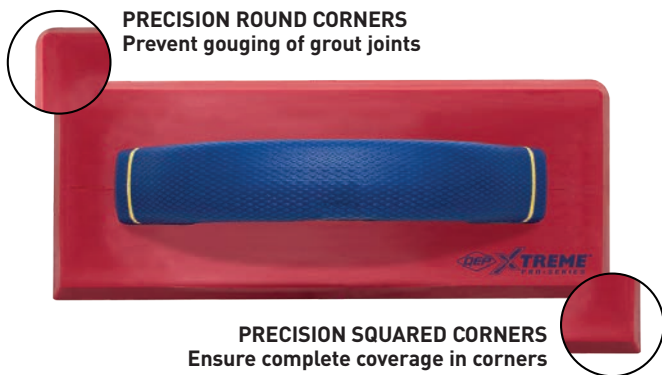

**PRECISION SQUARED CORNERS**  
Ensure complete coverage in corners

- Soft body design provides maximum flex and leverage for working grout into tile joints, with sanded and non-sanded grouts, for textured tile and natural stone
- Inner aluminum backing plate offers strength and stability
- Squared corners ensure complete coverage in corners



Maximum flex for all grout types

Item No.	Description	Case Qty	Packaging
10069	Xtreme Stone Grout Float, 10" x 4"	12	Shelf Case



SCAN HERE FOR MORE PRODUCT INFORMATION

# Universal Float



**PRECISION ROUND CORNERS**  
Prevent gouging of grout joints



**PRECISION SQUARED CORNERS**  
Ensure complete coverage in corners

- Non-stick gum rubber ensures smooth application for all grout types including epoxy
- 2-rounded corners prevent gouging of grout joints
- 2-square corners ensure complete grout coverage in corners
- Extra thick aluminum backing plate for maximum leverage and applying grout into joints.
- Comfortable, contoured and cushioned grip handle

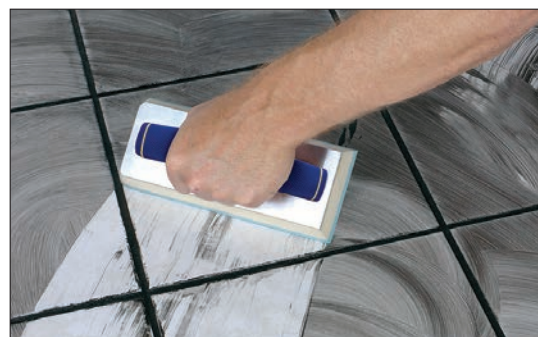

Item No.	Description	Case Qty	Packaging
10074-8	Universal Float 9½" x 4"	8	Shelf Case



# Gum Rubber Grout Float



- Non-stick gum rubber ensures even application and maximum removal
- 2-rounded corners prevent gouging of grout joints
- 2-square corners ensure complete grout coverage in corners
- Extra thick aluminum backing plate for maximum leverage and applying grout into joints
- Premium gum rubber laminated to lightweight, closed cell core is built to last



Item No.	Description	Case Qty	Packaging
10070	Gum Rubber Grout Float, Wood Handle, 10½" x 4"	12	Shelf Case

# Molded Rubber Grout Float



- Non-stick 5/8" molded gum rubber pad prevents absorption of materials
- Aluminum back plate for durability and beveled sides for a smooth application



Item No.	Description	Case Qty	Packaging
10060	Molded Rubber Grout Float 9½" x 4"	12	Shelf Case

# Grout Float



- High-impact plastic handle with closed cell foam rubber pad for a smooth application



Item No.	Description	Case Qty	Packaging
10062	Grout Float 9" x 4"	24	Shelf Case



# DIAMOND TOOLS

QEP Diamond tools are manufactured using a state-of-the-art brazed diamond bonding process to deliver consistent performance on even the toughest of porcelain.

Using the highest-quality industrial diamonds, our superior coating process allows for precise application of diamond grit, ensuring cleaner and more accurate holes and cuts.

Our thin and precise diamond grit edges are optimized for long life and fast cutting with cordless tools.



# X-TREME PRO-SERIES Diamond Hole Saws

QEP's Diamond Hole Saws deliver fast and accurate wet or dry cutting of porcelain, stone, marble, ceramic, and glass tiles.

Tough and strong, these Diamond Hole Saws attach to drills, cutting with precision and good resistance to wear, making them ideal to use when installing fixtures, or working around pipes.

up to  
**12X**  
LONGER LIFE  
than standard hole saws

# X-TREME PRO-SERIES Diamond Hole Saws for Drills

For cutting holes in glass, ceramic, porcelain, marble and granite

- Advanced metallurgical technology bonds diamond grit to chrome alloy steel base to produce a long lasting cutting edge
- Extremely durable and built to last longer than conventional diamond drill bits and standard hole saws
- Simply dip in water, no need for a constant water delivery system, for quick and easy use
- Fits standard 3/8" or 1/2" drill chucks



Item No.	Description	Case Qty	Packaging
10071	Xtreme 3/16" Diamond Hole Saw	6	Hang Card
10075	Xtreme 1/4" Diamond Hole Saw	6	Hang Card
10075-8	Xtreme 1/4" Diamond Hole Saw 8 pk	6	Carton
10080	Xtreme 5/16" Diamond Hole Saw	6	Hang Card
10080-8	Xtreme 5/16" Diamond Hole Saw 8 pk	6	Carton
10087	Xtreme 1-3/8" Diamond Hole Saw	6	Hang Card
10087-8	Xtreme 1-3/8" Diamond Hole Saw 8 pk	6	Carton



SCAN HERE FOR MORE PRODUCT INFORMATION

# wax/DRY X-TREME PRO-SERIES Diamond Hole Saw Kit

For drilling all types of ceramic tile, porcelain, stone, marble and granite



- Convenient kit contains 4 size: 1/4", 5/16", 3/8" & 1/2" (6 mm, 8 mm, 10 mm, 12 mm)
- Ideal for placing bathroom accessories or any type of decoration accessory on ceramic surfaces
- Simply dip in water, no need for a constant water delivery system, for quick and easy use
- Wax lubricant for cooling the diamond edge



Item No.	Description	Case Qty	Packaging
10485	wax/DRY Xtreme Diamond Hole Saw Kit	6	Hang Card

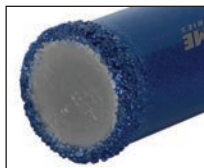

SCAN HERE FOR MORE PRODUCT INFORMATION

# **X-TREME** PRO-SERIES Diamond Hole Saws for Angle Grinders

For fast, clean hole cutting in porcelain tile, ceramic tile, granite, marble and slate



- Last at least 12x longer than drill attachment
- Superior brazing technology ensures diamonds stay bonded
- Simply dip in water, no need for a constant water delivery system, for quick and easy use
- Wax lubricant for cooling the diamond edge (3/16", 1/4", 5/16" sizes)



up to  
**50%  
FASTER**  
THAN A DRILL



Item No.	Description	Case Qty	Packaging
10468	Xtreme 3/16" Hole Saw for grinder	6	Hang Card
10469	Xtreme 1/4" Hole Saw for grinder	6	Hang Card
10470	Xtreme 5/16" Hole Saw for grinder	6	Hang Card
10471	Xtreme 1" Hole Saw for grinder	6	Hang Card
10472	Xtreme 1-3/8" Hole Saw for grinder	6	Hang Card
10473	Xtreme 2" Hole Saw for grinder	6	Hang Card
10474	Xtreme 2-1/2" Hole Saw for grinder	6	Hang Card
10475	Xtreme 4" Hole Saw for grinder	6	Hang Card



SCAN HERE FOR MORE PRODUCT INFORMATION

# **X-TREME** PRO-SERIES Diamond Undercut & Grout Remover Blade

**NEW**



- Diamond grit technology
- Fast grout removal
- No adapter is required
- Works with all materials with curved edge for more control
- Open-LOK anchor for fast blade changes

up to  
**12X**  
LONGER LIFE  
than standard blades



Item No.	Description	Case Qty	Packaging
10088	Diamond grit grout removal curved blade	6	Hang Card
10089	Diamond grit grout removal linear blade	6	Hang Card



SCAN HERE FOR MORE PRODUCT INFORMATION



# 3" Diamond Jigsaw Blade



- For cutting hard materials, including porcelain and ceramic tile
- Cuts faster and cleaner than standard carbide blades
- Heat treated alloy steel backer for superior strength



Item No.	Description	Case Qty	Packaging
10585	3" Diamond Jigsaw Blade	6	Hang Card

# Diamond Drill Bit with Water Delivery System



**20% MORE  
Diamond Grit**

- Ideal for cutting holes when installing towel bars, soap dishes, shelves, cabinets and shower door frames
- Diamond Grit edge drills through ceramic, glass, marble, porcelain and granite
- Convenient, single piece water delivery system keeps hole saw cool for a longer life
- Fits standard 1/2" or 3/8" drill chucks
- Kit includes 8 adhesive pads, water cooling system, drill guide and drill bit
- Only for wet use with cordless drills



Item No.	Description	Case Qty	Packaging
10571	5/16" Porcelain Diamond Drill Bit w/Drill Guide and Water Cooling System	6	Hang Card
10572	1/4" Porcelain Diamond Drill Bit w/Drill Guide and Water Cooling System	6	Hang Card

⚠WARNING: Cancer and Reproductive Harm- [www.P65Warnings.ca.gov](http://www.P65Warnings.ca.gov). See P. 89, \*Prop 65 - 1.

# Diamond Hole Saw with Water Delivery System

- For cutting 1-3/8" diameter holes in glass, ceramic, porcelain, marble and granite
- Special diamond grit edge for faster smoother cuts
- Included drill guide and water cooling cup easily supplies water to drill bit (use wet-only)
- Fits standard 1/2" or 3/8" drill chucks
- Includes 6 adhesive strips, water cooling cup and 1-3/8" diameter x 3" tall drill bit
- Only for wet use with cordless drills



Item No.	Description	Case Qty	Packaging
10569	1-3/8" Porcelain Diamond Hole Saw w/Drill Guide and Water Cooling System	6	Hang Card
10570	1-3/8" Hole Saw Extra Mounting Tape	6/cs (12 pc/bag)	Hang Card

# XTREME<sup>PRO-SERIES</sup> Diamond Milling Bits & Cones

Designed to enlarge, shape and round bevel existing holes in porcelain, hard ceramic, granite and marble

- Works on all standard grinders, no adaptor necessary



Item No.	Description	Case Qty	Packaging
10051	Xtreme 3/8" Diamond Milling Bit	6	Hang Card
10052	Xtreme 3/4" Diamond Milling Bit	6	Hang Card
10066	Xtreme 1-1/2" Diamond Milling Cone	6	Hang Card



SCAN HERE FOR MORE PRODUCT INFORMATION

## Diamond Sanding Blocks

- Smooth tile, stone, granite, glass, ceramic, and marble
- Manufactured with superior brazed diamond bonding and a lightweight foam base
- Flexible and easy to use in hard to reach places, corners, and edges
- Can be used wet or dry



Item No.	Description	Case Qty	Packaging
10046	60 Grit Sanding Block	6	Hang Card
10047	120 Grit Sanding Block	6	Hang Card
10048	200 Grit Sanding Block	6	Hang Card
10049	400 Grit Sanding Block	6	Hang Card



10046 60 COARSE GRIT    10047 120 MEDIUM GRIT    10048 200 FINE GRIT    10049 400 POLISHING GRIT

Grit	Purpose
60	Aggressive coarse grit for high rough spots
120	Medium grit for smoothing
200	Fine grit for smoothing
400	Smooth for polishing



SCAN HERE FOR MORE PRODUCT INFORMATION



# Diamond Grit File



- The high quality diamond bond strength maintains a tough grit surface for working with the hardest materials, including ceramic, porcelain, glass and stone
- Can also be used to smooth other materials, including fiberglass, laminate flooring, cement board and carbon fiber
- Flat/round profiles allow for smoothing both straight and curved edges
- Co-molded plastic handle with non-slip, rubber grip for comfortable repeat use



Item No.	Description	Case Qty	Packaging
10586-6	Diamond Grit File	6	Hang Card

# Pro Grout Saw



2 BLADES INCLUDED

- Curved heavy duty carbide blades easily remove stubborn grout
- Blade storage in handle can hold up to 2 blades
- Use 1 blade for thinner grout lines and 2 blades for wider grout lines



Item No.	Description	Case Qty	Packaging
10093	Pro Grout Saw	6	Hang Card
75011	Replacement Grout Saw Blades 2 pack	6	Hang Card

# Grout Saw



2 BLADES INCLUDED

- Strips, cleans and removes old grout, may be used on all grout types
- Includes 1 steel tooth blade for removing tough grout and 1 carbide grit blade for finishing and fine removal
- Use both blades for wide grout lines



Item No.	Description	Case Qty	Packaging
10057	Grout Saw	12	Hang Card
75011	Replacement Grout Saw Blades 2 pack	6	Hang Card

# Grout Saw Blades



- Replacement blades for the Pro Grout Saw and the Grout Saw 10093, 10093C, 10057, 10057C



Item No.	Description	Case Qty	Packaging
75011	Replacement Grout Saw Blades 2 pack	6	Hang Card



# INSTALLATION & BACKERBOARD TOOLS

Mixers, Nippers, Specialty Tools, Suction Cups, Grout Removers, Mallets, Knives, Tape, Sponges, Gloves, and more is what you will find in our Installation and Backerboard Tool assortment!



# Power Mixer Pro

Designed to mix thinset, grout, mortar, and other viscous materials

- High torque powerful 1400 Watt motor
- 0-800 RPM variable speed dial to prevent initial splash
- Lock-on function keeps mixer at desired RPM without holding the trigger



0-800 RPM variable speed dial

Includes 1/2" Chuck Kit

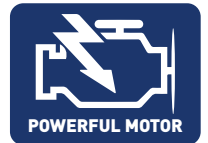

## SPECIFICATIONS

Item No	21700
Motor	120 V ~ 1400 Watts 1st gear: 0-480 RPM 2nd gear: 0-800RPM
Amps	12½
Weight	10½ lbs.

Item No.	Description	Case Qty	Packaging
21700	Power Mixer Pro w/ Paddle	1	Color Carton
21661	24" Pro Mixing Paddle (Replacement)	1	Shelf Case



SCAN HERE FOR MORE PRODUCT INFORMATION

# Pro Mixing Paddles

QEP offers a variety of mixing paddles for fast and effective mixing of grouts, thinsets and other setting materials

## 30" XL Spiral Pro Mixer



Designed to reduce air in mixture

Item No.	Description	Blade Width	Case Qty	Packaging
61230	30" XL Spiral Pro Mixer	5½"	6	Shelf Case

## 24" Pro Mixing Paddle



• fits Power Mixer Pro 21700

Item No.	Description	Blade Width	Case Qty	Packaging
21661	24" Pro Mixing Paddle	5½"	1	Shelf Case

## 23½" Pro Mixing Paddle



Available in 30 count floor displays  
61205D  
see page 76

Item No.	Description	Blade Width	Case Qty	Packaging
61205	23½" Pro Mixing Paddle	4-7/8"	8	Shelf Case
61205D	23½" Pro Mixing Paddle Display	4-7/8"	30	Floor Display

## 23½" Thinset and Grout Mixing Paddle



Item No.	Description	Blade Width	Case Qty	Packaging
75001Q	23½" Thinset and Grout Mixing Paddle	8¼"	6	Shelf Case

## 16" Universal Mixing Paddle



Fits in 1 Gallon Bucket

Item No.	Description	Blade Width	Case Qty	Packaging
61210	16" Universal Mixing Paddle	3¼"	12	Shelf Case



## **X**TREME<sup>™</sup> PRO-SERIES Pro Control Glass Tile Nipper

Designed for cutting irregular shapes in glass tiles and mosaics up to 5/16" thick

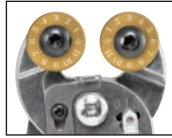

SharpTrack Cutting Wheels identify used cutting edges



- Aluminum lightweight body
- 7/8" titanium coated tungsten carbide cutting wheels for long lasting toughness and durability
- 3-position Tile Thickness Lock minimizes hand fatigue during repeat cutting of the same tile thicknesses
- Internal rubber bumpers prevent impact shock

Item No.	Description	Case Qty	Packaging
32014	Xtreme Pro Control Glass Tile Nipper	6	Hang Card

⚠WARNING: Cancer and Reproductive Harm- www.P65Warnings.ca.gov. See P. 89, \*Prop 65 - 1.



SCAN HERE FOR MORE PRODUCT INFORMATION

## Glass Tile Nipper



- Cuts irregular shapes in glass tile and mosaics from 1/32" to 1/4" thick
- Ideal for quickly cutting small mosaic pieces of glass and removing tiny points from glass tile
- Single piece, drop-forged steel construction for maximum strength with comfortable, contoured handles

Item No.	Description	Case Qty	Packaging
32010	Glass Tile Nipper	6	Hang Card

## **X**TREME<sup>™</sup> PRO-SERIES Offset Tile Nipper

Steel construction with protective coating and tough, tungsten carbide tips for long lasting use



- Designed for cutting irregular shapes in ceramic and porcelain tile up to 5/16" thick
- Contoured, rubberized handle is more comfortable in the hand
- Offset tungsten carbide tips for more control when making irregular and curved cuts
- Helps fit tile around oddly-shaped objects, like pipes or sinks
- Internal rubber bumpers prevent impact shock

Item No.	Description	Case Qty	Packaging
10103	Xtreme Offset Tile Nipper	6	Hang Card

⚠WARNING: Cancer and Reproductive Harm- www.P65Warnings.ca.gov. See P. 89, \*Prop 65 - 1.



SCAN HERE FOR MORE PRODUCT INFORMATION

## Compound Tile Nipper



- Compound mechanism delivers 3 times more force with less effort
- Use to cut irregular shapes in all tile from 1/8" to 1/4" thick
- Durable tungsten carbide tip provides a long cutting life
- Co-molded plastic handle with non-slip, rubber grip for comfortable repeat use

Item No.	Description	Case Qty	Packaging
32036	Compound Tile Nipper	6	Hang Card

# Tile Nipper



- 8" carbide tipped nippers with offset jaws
- For cutting irregular shapes in tile from 1/8" to 1/4" thick
- Single piece, drop-forged steel construction for maximum strength

Item No.	Description	Case Qty	Packaging
10003	Tile Nipper	12	Hang Card

# Tile Cutter



- Recommended for manually scoring and cutting ceramic wall tiles up to 6" x 6" and 1/4" thick
- Uses a durable tungsten carbide wheel for scoring and a breaker bar to "snap" ceramic tile

Item No.	Description	Case Qty	Packaging
32024	Tile Cutter	6	Hang Card

# 6" Locking Contour Gauge



Irregular shapes are locked into place



- Easily forms around any shape for a precise template, reducing waste created when guessing the dimension of irregular shapes
- Locking feature holds patterns in place while tracing on any surface
- Great for marking precise cutouts in vinyl, wood, porcelain and ceramic tiles

Item No.	Description	Case Qty	Packaging
10038	6" Locking Contour Gauge	1	Hang Card

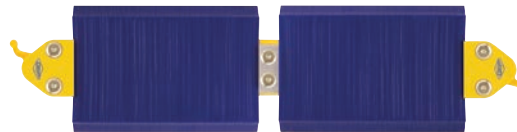

Combine 2 Gauges for longer profiles

# Wax China Markers

**NEW**

2-Pack



- Premium markers made with a superior wax blend for seamless writing on both non-porous and most porous surfaces.
- Perfect for porcelain, glass, ceramics or polished stone
- Resistant to moisture, and markings wipe off easily, making it an ideal choice for a variety of projects
- Easy-tear string, no need for sharpening



Item No.	Description	Case Qty	Packaging
38779	Wax China Markers - 2 Pack - 1 black/1 red	12	Hang Card



# Suction Cups

QEP offers a wide array of suction cups for lifting large format tile. Heavy-duty options include single suction cup design, double suction cups and our newest addition, pump suction cups for even more holding power. Let us do the heavy lifting!

## **X**TREME PRO-SERIES 8" Electric Suction Cup

Hand held, portable tool for lifting large tiles, stone, glass, and more



- Built in air sensor provides steady suction with 48 hour non-stop running time
- Multi-layered sealed safety rim
- Digital LED display indicating battery life
- Rechargeable Lithium-ion battery (6-8 hours charging time)
- USB-C charging cable and durable carrying case

Item No.	Description	Case Qty	Packaging
75024	Xtreme Pro Series 8" Electric Suction Cup	3	Carton

⚠️WARNING: Cancer and Reproductive Harm- www.P65Warnings.ca.gov. See P. 89, \*Prop 65 - 1.



SCAN HERE FOR PRODUCT VIDEO

## 8" Pump Suction Cup with Gauge



- Hand held, portable tool for lifting large tiles, stone, glass, and more
- Red line indicator shows when to engage suction
- Safety gauge to monitor suction
- Anti-slip sealed safety rim



Item No.	Description	Case Qty	Packaging
75022	8" Pump Suction Cup with Gauge	3	Carton

⚠️WARNING: Cancer and Reproductive Harm- www.P65Warnings.ca.gov. See P. 89, \*Prop 65 - 1.



SCAN HERE FOR MORE PRODUCT INFORMATION

## 8" Vacuum Pump Suction Cup



- Hand held, portable tool for lifting large tiles, stone, glass, and more
- Red line indicator shows when to engage suction
- Sealed safely rim line



Item No.	Description	Case Qty	Packaging
75021	8" Vacuum Pump Suction Cup	3	Carton

⚠️WARNING: Cancer and Reproductive Harm- www.P65Warnings.ca.gov. See P. 89, \*Prop 65 - 1.



SCAN HERE FOR MORE PRODUCT INFORMATION

## X-TREME PRO-SERIES Double Suction Cup

Designed for maneuvering non-porous, smooth tiles, stone, marble, cultured marble, granite and glass during horizontal and vertical applications



- 200 lb. holding capacity is ideal for large format tile
- Rigid, aluminum alloy body with textured, non-slip grip
- Two, 4-3/4" durable rubber pads will not mar tile
- Hold-and-release levers for easy, secure use



Item No.	Description	Case Qty	Packaging
75012	Xtreme Double Suction Cup	3	Shelf Case

⚠ WARNING: Cancer and Reproductive Harm- www.P65Warnings.ca.gov. See P. 89, \*Prop 65 - 1.



SCAN HERE FOR MORE PRODUCT INFORMATION

## ProMAXGrip Double Suction Cup



- For use on clean, non-porous large format tile, stone and marble
- Dual action suction and release system
- Simple single hand operation
- Strong, textured, non-slip grip



Item No.	Description	Case Qty	Packaging
75013	ProMAX® Grip Double Suction Cup	3	Shelf Case

## Double Suction Cup



- Maximum vacuum hold to move smooth, non-porous tile, stone and cultured marble
- Heavy duty, aluminum frame



Item No.	Description	Case Qty	Packaging
75003	Double Suction Cup	3	Shelf Case

## Suction Cup



- For easy handling of non-porous tile, marble and glass during installation
- Suction cup pad is 4-1/2" in diameter
- 3-1/2" wide handle opening easily accommodates large hands



Item No.	Description	Case Qty	Packaging
75000	Suction Cup	6	Shelf Case



# Rubbing Stone



- Dual grit surfaces smooth rough edges on freshly cut ceramic & porcelain tile, stone, marble and brick
- Medium 60-grit on one side and fine 80-grit on the other
- Ideal for dressing diamond blades by exposing fresh diamonds in the blade rim

Item No.	Description	Case Qty	Packaging
10022	Rubbing Stone 6" x 2" x 1"	6	Hang Card

# Grout Remover

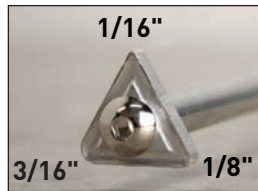

- For removing unwanted grout, mortar, thinset, calcium, caulking and surface rust
- Double-sided head with 3 durable carbide tips
- Includes 1/16", 1/8" and 3/16" tips for different grout line widths

Item No.	Description	Case Qty	Packaging
10020	Grout Remover	12	Hang Card

# Thinset Removal Tool



- For removing excess thinset between tiles, during installation
- Durable, easy to clean and will not scratch tile
- Clearly marked tips for most popular grout joints 1/16", 1/8", 3/16" and 1/4"
- Patent pending 4-in-1 flat, compact tool for easy storage and portability

Item No.	Description	Case Qty	Packaging
62963	Thinset Removal Tool	10	Hang Card

# Grout Sealer Applicator



- Includes (2) roller wheels for multiple grout widths:
  - Use 1/8" wheel for grout joints 1/8" and smaller
  - Use 1/4" wheel for grout joints 1/4" and larger
- Works with all grout sealers
- Patented roller wheel system provides complete coverage
- Holds 12 oz. (355 ml)

Item No.	Description	Case Qty	Packaging
10279	Grout Sealer Applicator	12	Hang Tab

- Great for small projects with narrow grout joints
- Works with all grout sealers
- Plastic bottle holds up to 4 oz. of grout sealer

Item No.	Description	Case Qty	Packaging
19999	Grout Sealer Brush Applicator	12	Hang Tab

# Grout Bag



- Reinforced tip for smooth application and long life
- Protects hands from grout and other harsh substances
- Made of puncture and tear resistant coated vinyl

Item No.	Description	Case Qty	Packaging
76000	Grout Bag	12	Shelf Case

# Multi-Use Trim Shears



- Easily cuts quarter round, tile trim, PVC piping, tackstrip and other light materials
- Makes fast angle cuts in wood quarter round, tile trim, PVC piping, tackstrip and other materials
- Eliminates the need for a chop or miter saw
- Miter guide is clearly marked at 45°, 90° and 120°

Item No.	Description	Case Qty	Packaging
10711	Multi-Use Trim Shears	6	Hang Card

# TileTrim Square™

Eliminates blade launching due to insufficient grip that often results in wasted materials and uneven cuts



- Features slots for holding metal trims, and profiles for 45° miter cuts
- V-groove for holding 1/4 rounds allows for a 45° miter cut, resulting in seamless inside and outside corners
- For use with wet saws and chop saws, and various cutting tools
- Works with 95% of tile trim in the market



Item No.	Description	Case Qty	Packaging
10715	TileTrim Square™	6	Shelf Case



SCAN HERE FOR PRODUCT VIDEO

# TILETRIM SQUARE



2024 top flooring products  
**AWARD WINNER**  
for tools and equipment





## Tile Mallet



- Measures 70-75 on the Shore A hardness scale, for a firm hardness with minimum bounce when striking
- Designed for installing tile, vinyl, laminate and wood flooring
- Large chamfered mallet head spreads force across the flooring to move it into place during installation
- 16 oz. white rubber head with co-molded plastic 11-1/2" handle with non-slip, rubber grip

Item No.	Description	Case Qty	Packaging
61625	Tile Mallet	3	Hang Handle

## White Rubber Mallet

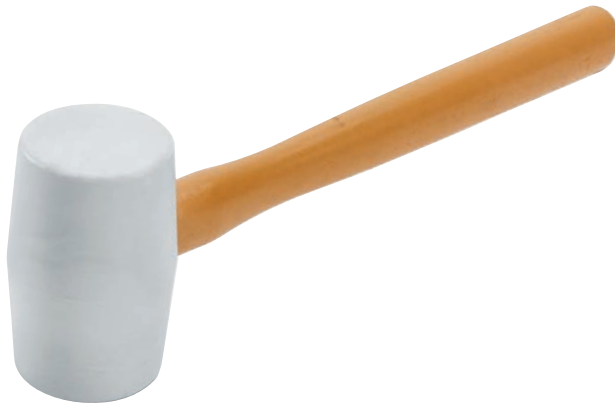

- 16 oz. rubber head securely mounted on hardwood handle
- 12-1/2" in length, 2" diameter rubber head

Item No.	Description	Case Qty	Packaging
61613	White Rubber Mallet	12	Shelf Case

## **X-TREME**™ Cement Backer Board

Available as Full Container Orders Only,  
Drop Ship Only!



- Zero Fire & Smoke Rating
- Mold, mildew and water resistant
- A better environmental alternative and upgrade to replace gypsum and cement backer board for walls, floors and countertops.
- Contains no silica, no asbestos, no VOC's, no harmful additives
- Contributes to LEED credits and NAHB Green Building Program Credits

Ratings	
R-Value	0.493 / in.
K-Value	2.03 BTU / °F-ft2-H

Item No.	Description	Pallet Qty	Packaging
73000	Backerboard, 1/4" Thick, 36" x 60"	100	Pallet
73001	Backerboard, 1/4" Thick, 48" x 96"	70	Pallet
73002	Backerboard, 1/2" Thick, 36" x 60"	50	Pallet
73005	Backerboard, 1/8" Thick, 36" x 60"	200	Pallet



SCAN HERE FOR MORE PRODUCT INFORMATION

# Folding Backerboard Knife



- Carbide multi-tip design, ideal for puncture and scoring
- Serrated blade base for cutting mesh
- Designed to score all types of backerboards
- Folding design for storage and safe transport
- Strong, lightweight aluminum handle with liner lock

Item No.	Description	Case Qty	Packaging
10072	Folding Backerboard Knife	6	Hang Card

# Backerboard Scoring Knife



- Long lasting carbide tips for scoring backerboard
- 2 tips deliver accurate, straight cuts
- Non-slip, rubber grip handle for comfortable repeat use

Item No.	Description	Case Qty	Packaging
10058	Backerboard Scoring Knife	12	Hang Card

# Board Seam Tape



- For use in seaming all types of cement backerboard and tile underlayment
- Alkali resistant fiberglass mesh, self-adhesive tape – reduces taping time
- Resists tears and will not shrink

Item No.	Description	Case Qty	Packaging
99600	Board Seam Tape – 2" x 50' roll	24	Shelf Case
99605	Cement Board Seam Tape – 2" x 150' roll	18	Shelf Case

# All-Purpose Heavy Duty Sponge

- 3rd party independent laboratory testing shows that the QEP Sponge outperforms other brands in Elongation, Tensile and Tear Strength
- Durable polyurethane material with hydrophilic cell design provides greater liquid-holding capacity for faster grout clean up
- Top choice for removing wet and drying grout during floor and wall installation
- Perfect for residential, commercial, auto, boat and RV cleaning



Rounded corners to prevent digging out or marring grout

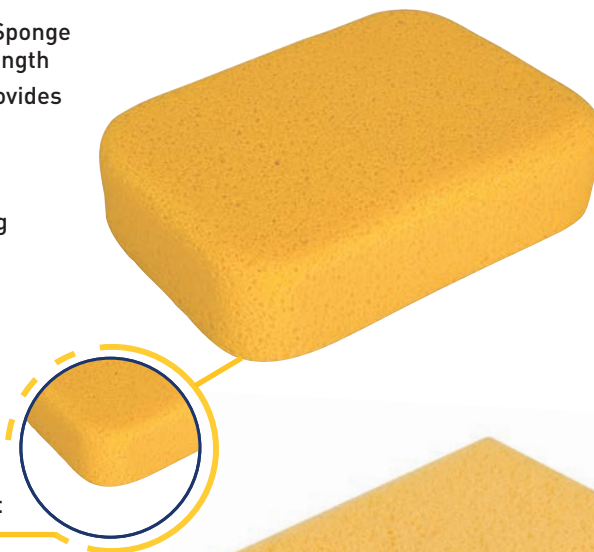

Square corners provide maximum performance when working with narrow grout lines and tight corners

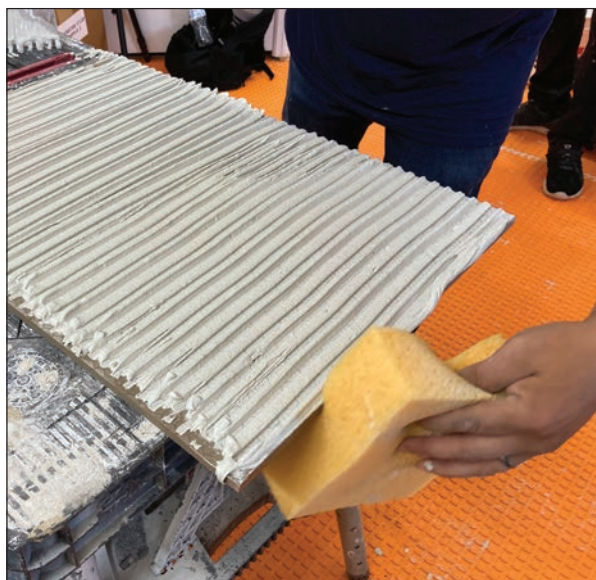
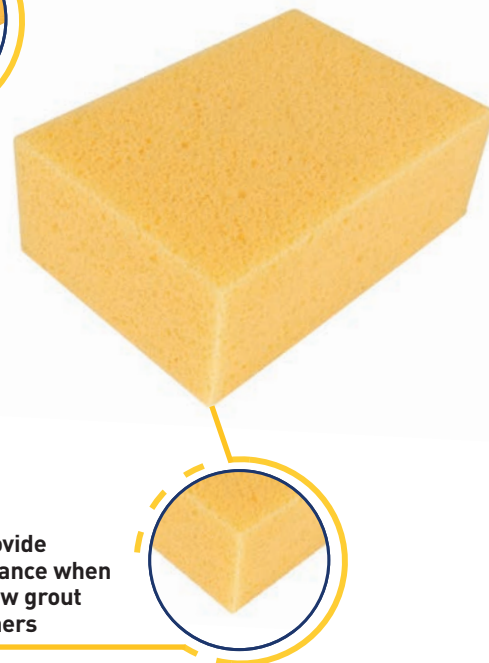

Rounded Corner – 7.5" x 5.5" x 1.875"			
Item No.	Description	Case Qty	Packaging
70005-24	All-Purpose Heavy Duty Sponge, Individually bagged	24	Shelf Case
70005Q-6D	All-Purpose Heavy Duty Sponge, Value <b>6 Pack</b>	24	Shelf Case
70005-750	All-Purpose Heavy Duty Sponge, Bulk Bale	750	Bale
70005D	All-Purpose Heavy Duty Single Pack Sponge Display	252	Floor Display
70005-3VPD	All-Purpose Heavy Duty <b>3 Pack</b> Sponge	84	Floor Display

QEP Canada Only			
Item No.	Description	Case Qty	Packaging
70005	XL All-Purpose Sponge, Bulk Bale	600	Bale
70005C-24	XL All-Purpose Sponge, Individually bagged	24	Shelf Case

Square Corner – 6.75" x 4.625" x 2.375"			
Item No.	Description	Case Qty	Packaging
70006-18	Pro Square Grouting Sponge, Individually bagged	18	Shelf Case



# Scrubbing Sponge



- Durable polyurethane material with hydrophilic cell design provides greater liquid-holding capacity for the initial grout clean up on one side
- Powerful scrubbing side to combat difficult residues
- Rounded corners to prevent digging out or marring grout
- Perfect for residential, commercial, auto, boat and RV cleaning
- 7-1/2" x 5-1/4" x 1-7/8"



Item No.	Description	Case Qty	Packaging
70007-24	Scrubbing Sponge, Individually bagged	24	Shelf Case
<b>QEP Canada Only</b>			
70007C-24	Scrubbing Sponge, Individually bagged - Only available in Canada	24	Shelf Case

# Microfiber Polishing Sponge



- Durable polyurethane material with hydrophilic cell design provides greater liquid-holding capacity for the initial grout clean up on one side
- Microfiber side ideal for grout haze removal, applying sealer and polishing tile
- Rounded corners to prevent digging out or marring grout
- Perfect for residential, commercial, auto, boat and RV cleaning
- 7-1/2" x 5-1/2" x 2"



Item No.	Description	Case Qty	Packaging
70010	Microfiber Polishing Sponge	24	Shelf Case
<b>QEP Canada Only</b>			
70010C-24	Microfiber Polishing Sponge - Only available in Canada	24	Shelf Case

## Microfiber Grout Cleaning Cloth



- Oversized, microfiber cloth for removing grout haze, as well as general dusting, washing and cleaning
- Soft, yet durable and heavy weight material is great for wet or dry use
- 100% microfiber cloth, including double sided edge stitching
- Machine washable, and great for general purpose cleaning on most home surfaces, including cars and boats

Item No.	Description	Case Qty	Packaging
70018	Microfiber Grout Cleaning Cloth 18" x 18"	12	Hang Card

## Microfiber Surface Cleaning Cloth



2-Pack

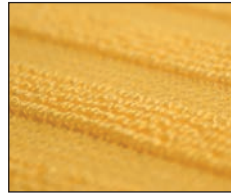

- High absorbency cloth absorbs up to 5x its weight in water
- Soft microfiber on one side, non-abrasive scrubbing micro-bristles on the other
- Rows of micro-bristles safely scrub away dried grout and tough to remove dirt and grime
- Machine washable

Item No.	Description	Case Qty	Packaging
70019	Microfiber Surface Cleaning Cloth 14" x 14" 2-Pack	12	Hang Card

## Polishing Cheesecloth



- For removing grout haze after installation
- 5 square yards (36" x 180")
- Great for polishing most tile surfaces to a bright shiny finish
- 100% cotton, professional grade fine mesh

Item No.	Description	Case Qty	Packaging
76030	Polishing Cheesecloth	12	Hang Card

## Heavy Duty Plastic Mixing Bucket



- Heavy duty 5-gallon bucket with lifting capacity up to 84 lbs
- Reinforced ring design allows several buckets to nest and separate easily
- Sturdy wire bail with a plastic handgrip for easy lifting
- Versatile for job sites, gardening and general use

Item No.	Description	Case Qty	Packaging
78105	QEP Heavy Duty 5 Gallon Plastic Mixing Bucket - White	1	Open Stock

## Large Handle Scrub Brush



Handle Sold Separately



- Features corner brush head design
- Stiff nylon V cut bristles for cleaning deep into grout
- Built in scraper for tough dirt and grime
- Swivel head pole attachment allows for use standing up and provides additional leverage

Item No.	Description	Case Qty	Packaging
20839	Large Handle Scrub Brush	8	Hang Card

## Grout Cleaning Brush



- Multi-purpose cleaning brush with outstanding performance on tile and grout
- Ergonomic handle includes thumb rest for leverage and comfort
- Durable, angled nylon bristles remove grime in creases

Item No.	Description	Case Qty	Packaging
20842	Grout Cleaning Brush	12	Hang Card

## Heavy Duty Multipurpose Gloves



- Chemical resistant - protects hands from the corrosive action of grout, chemicals and other harsh substances
- 100% heavy duty latex is puncture and tear resistant
- One size fits most
- Non-slip ribbing on thumb and finger surfaces



Item No.	Description	Case Qty	Packaging
21591	Heavy Duty Multipurpose Gloves	24	Shelf Case

## SureGrip Tiler's Gloves



2-Pack

- Provides excellent grip and dexterity when handling tile and stone
- Patented SureGrip® technology provides an over 400% better grip in wet conditions and 60% better grip in dry conditions compared to standard latex and nitrile material
- Durable, lightweight mesh fabric with elastic wrist band to keep gloves in place
- Touchscreen compatible for easy smartphone and tablet use without removing gloves
- 2 pair of gloves per set
- One size fits most

Item No.	Description	Case Qty	Packaging
21595	SureGrip® Tiler's Gloves (2 pairs of gloves)	10	Shelf Case

⚠ WARNING: Cancer and Reproductive Harm- [www.P65Warnings.ca.gov](http://www.P65Warnings.ca.gov). See P. 89, \*Prop 65 - 1.



## Floor & Wall Tile Installation Kit



- Complete kit containing all the tools necessary to install ceramic tile on floors

- Kit contains:
  - Double-sided trowel: 3/16" X 5/32" V notch
  - 1/4" X 1/4" X 1/4" Square notch
  - Comfort Grip 6" x 2" Margin Float
  - Sponge
  - Tear resistant, reinforced grip multipurpose gloves
  - Washable kneepads
  - Reusable 2.5 gallon plastic bucket

**SAVINGS  
ON KIT  
14%**

Item No.	Description	Case Qty	Packaging
78251	Floor & Wall Tile Installation Kit	1	Shelf Case

## Tile Installation Kit



- Complete kit containing all the tools necessary to install ceramic tile on floors

- Kit contains:
  - Molded rubber float
  - 1/4" x 3/8" x 1/4" square notch floor trowel
  - 8" tile nippers, sponge, disposable gloves
  - Reusable 2.5 gallon plastic bucket
  - Complete installation instructions

**SAVINGS  
ON KIT  
15%**

Item No.	Description	Case Qty	Packaging
78220Q	Tile Installation Kit	1	Shelf Case
<b>QEP Canada Only</b>			
78220QC	Tile Installation Kit	1	Shelf Case

## Toilet Installation Kit & Accessories

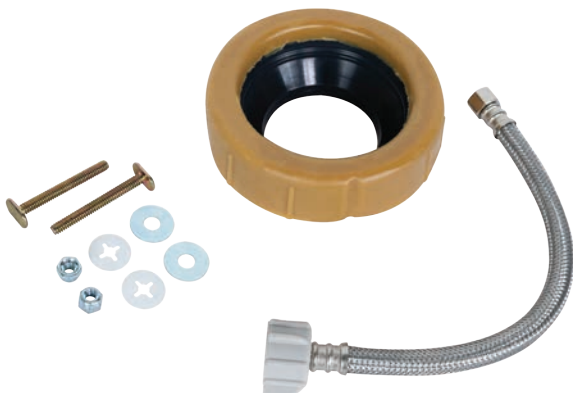

- Includes: Harvey No-Seep® No. 50 Extra Thick Wax Ring with alignment flange, Fluidmaster® 12" SS Braided Toilet Connector, Bolt Kit - 1/4" x 2-1/4" brass-plated closet bolts with nuts and washers

Item No.	Description	Case Qty	Packaging
38229	Toilet Installation Kit with 12" Connector	1	Shelf Case

# POWERFUL ADJUSTABLE VERSATILE



10-56  
LONGNECK PLUS  
6" JAMB SAW



10-46  
SUPER SIX  
6" JAMB SAW

ROBERTS® Super Six and Longneck Plus 6" Jamb Saws are powerful and versatile tools that meet a wide variety of undercutting needs. From doorjamb and molding to under toekicks and undercut doors, we're ready for all of your flooring installation needs. Featuring adjustable cutting depth guides (to prevent cutting into plaster or wallboards) and precision height specifications (allowing cuts from flush to 1-1/16" above the floor) our ROBERTS Jamb Saws help get the job done right every time.

Supporting Professional Installers Since 1938



robertsconsolidated.com 866.435.8665

Scan here for  
PRODUCT  
INFORMATION

10-46 Super Six  
6" Jamb Saw



10-56 Longneck Plus  
6" Jamb Saw





## TEAR-OUT TOOLS

When starting a new project, QEP knows scrapers and chisels need to be strong and durable to get the job done. We offer smaller handheld options, chisels and scrapers that can accommodate handles for extended reach and traditional demolition, surface and floor scrapers. All of these tools are designed for better leverage, comfort and control while working.



# 14" Surface Scraper



- Flexible carbon steel blade for removing old floors and cleaning up excess debris
- All welded construction made of pipe steel with a replaceable flexible blade
- Great for removing tile, vinyl, carpet glue, plaster and popcorn ceilings
- 5' long handle for leverage



Item No.	Description	Case Qty	Packaging
20900Q	14" Surface Scraper	6	Hang Card
21000Q	14" Replacement Blade	3	Hang Card
<b>QEP Canada Only</b>			
20900C	14" Surface Scraper	6	Hang Card

# 7" Heavy Duty Floor Scraper



- Rigid carbon steel blade for scraping up ceramic tile, concrete, marble, and wood floors
- All welded construction made of pipe steel with a replaceable rigid blade
- Rips up roofing and vinyl flooring; chips away cement and plaster
- 4' long handle includes foot peg for better leverage on difficult projects
- Also great for ice removal

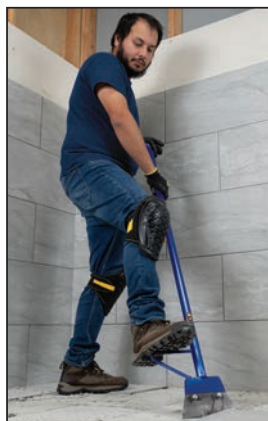

Item No.	Description	Case Qty	Packaging
75006Q	7" Heavy-Duty Floor Scraper	6	Hang Card
75007Q	7" Replacement Blade	3	Hang Card
<b>QEP Canada Only</b>			
75017C	7" Heavy-Duty Floor Scraper	6	Hang Card

# Demolition Scraper



- Unique reversible hardened steel blade can easily be converted from 5" to 3" wide (ideal for scraping in tight areas)
- Double angled design offers increased leverage during scraping and prying
- Great for removing tile, wood, laminate, stone, carpet, ice and roofing
- Resharpenable hard steel (use file or grinder)
- Galvanized steel ergonomic handle reduces fatigue

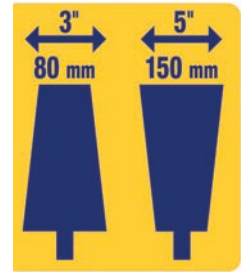

Item No.	Description	Case Qty	Packaging
62965Q	Demolition Scraper	3	Hang Card

# 8" Adjustable Razor Floor Scraper



Includes canvas cover



- 15° angled stainless steel blade head for removing old adhesive, vinyl, carpet and other flooring materials
- All welded construction made of pipe steel with a replaceable blade
- Twist lock adjustable telescoping handle adjusts from 3' to 6' in length
- Deluxe cushioned grip handle provides added comfort when scraping

Item No.	Description	Case Qty	Packaging
62909Q	8" Adjustable Razor Floor Stripper	6	Hang Card
62909-12	8" Adjustable Razor Floor Stripper Canvas Cover- replacement	1	Plastic Bag
<b>Replacement Blades</b>			
62904Q	8" Stripper Blades (3 on a skincard)	10	Hang Card
62907Q	8" Stripper Blades (10 on a skincard)	1	Hang Card
<b>QEP Canada Only</b>			
62909QC	8" Adjustable Razor Floor Stripper	6	Hang Card

# 4" Razor Scraper

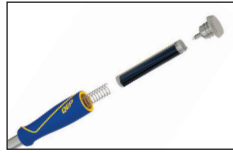

- Handle features internal blade storage and built-in screwdriver for easy accessibility
- Attach handle to a threaded pole for an extended reach
- Metal hammer end for use on stubborn material
- Includes five 4" stainless steel blades
- Co-molded plastic handle core with non-slip, rubber grip

Item No.	Description	Case Qty	Packaging
62920	4" Razor Scraper	6	Hang Card
<b>Replacement Blades</b>			
62901	4" Razor Scraper Blades (5 on a skincard)	6	Hang Card

# **X**TREME PRO-SERIES Heavy Duty Chisel Scraper

For splitting and breaking concrete, brick and more



- Features over strike impact guard
- Industrial grade with rust preventative coating
- Precision ground cutting edge
- Shock-absorb handle features non-slip grip for added control

Item No.	Description	Case Qty	Packaging
62971	Xtreme Heavy Duty Chisel	4	Hang Card



SCAN HERE FOR MORE PRODUCT INFORMATION

# Chisel Scraper



- Heavy duty 3" stainless steel blade
- Attach handle to a threaded pole for an extended reach
- End of handle features a metal cap which can be struck with a rubber mallet for stubborn material
- Co-molded plastic handle core with non-slip, rubber grip

Item No.	Description	Case Qty	Packaging
62972	Chisel Scraper	6	Hang Card





# KNEE PADS

Offering installers several designs for knee protection, QEP prioritizes your time and safety. From EVA foam and memory foam to encapsulated gel layers, we've got you covered. Most QEP kneepads also offer convenient side loops for pen storage to quickly make marks.



# ProMAXGel Knee Pads



- Gel layer is fully encapsulated in EVA foam to prevent delamination and minimize wear
- Textured cap surface for a non-slip grip and moisture-wicking neoprene liner for comfort
- Micro hook and loop fastening technology down the length of the strap for a perfect fit
- Convenient side pen loops for pen storage

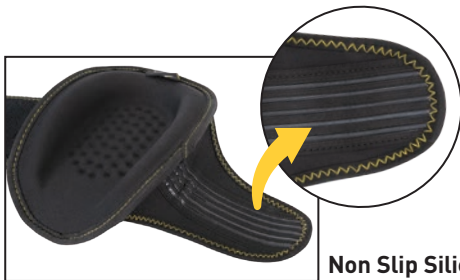

Non Slip Silicone Grips

Item No.	Description	Case Qty	Packaging
79645	ProMAX® Gel Knee Pads	6	Hang Card Shelf Case
79645D	ProMAX® Gel Knee Pad Display	20 pair per display	Floor Display see page 67

# Comfort Grip Knee Pads



- Comfortable EVA form-fitting foam padding for cushioning
- Soft neoprene inner lining will not adsorb sweat so the knee pads won't develop an odor
- Stretching, neoprene strap with adjustable hook and loop fasteners hold the knee pads in place
- Convenient side pen loops for pen storage



Item No.	Description	Case Qty	Packaging
79634	Comfort Grip Knee Pads	8	Hang Card Shelf Case

## Comfort Wrap Technology *with Memory Foam*



- Memory foam conforms to your knee shape for a custom fit
- XL Patella Gel Zone and 5 Layer Comfort System provides extended total knee comfort
- Soft Cap Stabilizer for hard or soft surfaces
- Micro hook and loop fastening technology on the entire strap length for a perfect fit
- Convenient side pen loops for pen storage



Item No.	Description	Case Qty	Packaging
79642	F3 Stabilizer Professional Knee Pads	6	Hang Card Shelf Case

## Washable Knee Pads



- Compression molded EVA foam for easy washing with a neoprene liner for comfort
- Economical and lightweight for comfort and easy mobility
- Adjustable hook and loop fastening straps hold the knee pads in place



Item No.	Description	Case Qty	Packaging
79640	Washable Knee Pads	14	Hang Card





# UNDERLAYMENTS & BARRIERS

QEP offers both cork underlayments and Aquabar® "B" Moisture Vapor Barrier to enhance crack suppression. Natural Cork Underlayments help control sound under ceramic tile and stone and reduce thermal transmissions.

# Benefits of Cork Underlayment



A staple in green building, cork offers superior durability, is impermeable, resistant to mold, mildew, and termites. A natural insulator, cork is fire resistant, and provides unrivaled noise reduction properties.

Our cork sheets and rolls exceed the International Building Code requirements for ambient and impactsound transmission. Cork is an excellent resource for underlayment, and comes from a renewable resource. Cork underlayment is carbon negative and is the exceptional choice.

Using cork underlayment contributes to LEED Green Building Credits.

## Natural Cork Sheets



- Reduces sound transmission from both the surface of a floor as well as through the floor to living spaces below
- Use under ceramic tile, stone, marble, engineered hardwood and laminate floors
- Acts as a crack isolation membrane that resists transfer of stress cracks from subfloor through to flooring surfaces
- Reduces thermal transmission, increasing the effectiveness of floor heating systems
- Each sheet: 2' x 3'



	Test Results	IIC Rating*	STC Rating**	Δ Rating***
72005Q	With 6" cement slab & suspended ceiling	74	70	22

Item No.	Description	Case Qty	Packaging
72005Q	1/4" (6 mm) Sheets - 30 sq. ft./pack, (5 sh/pk)	8	Shelf Case
72001Q	1/2" (12 mm) Sheets - 150 sq. ft./case, (25 sh/cs)	1	Shelf Case

## Natural Cork Roll



- Reduces sound transmission from both the surface of a floor as well as through the floor to living spaces below
- Use under ceramic tile, stone, marble, engineered hardwood and laminate floors
- Acts as a crack isolation membrane that resists transfer of stress cracks from subfloor through to flooring surfaces
- Reduces thermal transmission, increasing the effectiveness of floor heating systems



	Test Results	IIC Rating*	STC Rating**	Δ Rating***
72000Q	With 6" cement slab & suspended ceiling	74	70	22
72003Q	With 6" cement slab & suspended ceiling	74	70	22

Item No.	Description	Case Qty	Packaging
72000Q	1/4" (6 mm) Natural Cork 200 sq. ft. roll, 48" x 50'	1	Roll
72003Q	1/4" (6 mm) Natural Cork 100 sq. ft. roll, 48" x 25'	1	Roll

## Aquabar® "B" Moisture Vapor Barrier



- Sub-floor barrier helps prevent buckling, cupping and cracking
- Ideal for interior installations of: ceramic, porcelain or stone over cement board, plywood or concrete; and, finished or unfinished wood floors over plywood or concrete

Item No.	Description	Case Qty	Packaging
70-195	Aquabar "B" Moisture Vapor Barrier - 500 sq. ft., 36" x 167'	1	Roll

\*IIC measures sound such as moving furniture and walking, \*\*STC measures sound such as voices and television. Minimum sound rating required by most building codes and architects is 50. \*\*\*Δ Delta Rating is the only true measurement of sound reduction from a product (not a floor assembly) in the industry.





# DISPLAYS & MERCHANDISING

We are pleased to offer both promotional floor stands and permanent fixtures for some of our best-selling installation tools. The floor displays are made of cardboard which can be recycled and the countertop displays can be used for any QEP product you would like to feature. Our 4' and 8' QEP branded gondola fixtures are designed to hold pegged product, shelf cartons and boxes. The gondola presentation allows for the full range of QEP tile tools to be merchandised together with overhead signage.



# Corrugated Floor Displays

Perfect for promotions or secondary placement.

## Single Pack Sponge

Professional, heavy duty sponge for grout clean-up

**252**  
Sponges  
per display

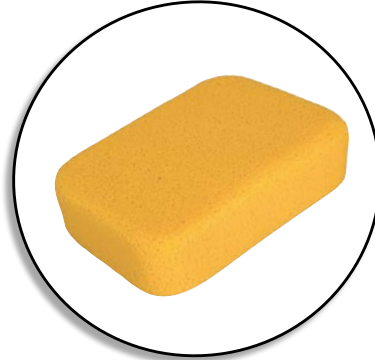

70005D  
Heavy Duty All Purpose  
Single Pack Sponge Floor Display

## 3-Pack Sponge

Foam density is engineered for quicker grout pick-up and faster rinse

**84**  
3-packs  
per display

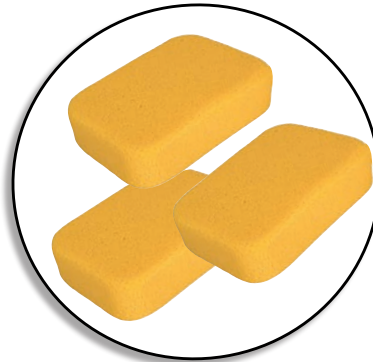

70005-3VPD  
Heavy Duty All-Purpose  
3-Pack Sponge Floor Display

## Square Sponge

Square corners for maximum performance when working with narrow grout lines and tight corners

**255**  
Sponges  
per display

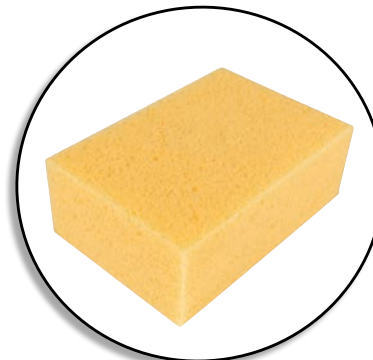

70006D  
Pro Square  
Grouting Sponges  
Floor Display



# Corrugated Floor Displays

Perfect for promotions or secondary placement.

## Mixers

23-1/2" Pro Mixing Paddle  
for fast effective and mixing of  
grouts, thinsets and other materials

**30**  
Mixers  
per display

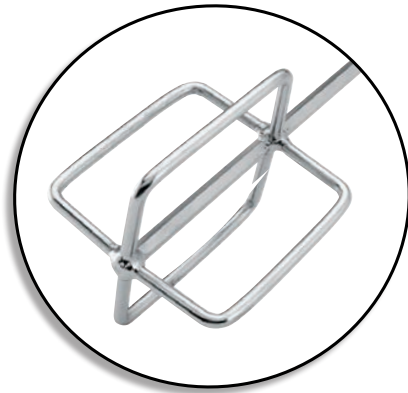

61205D  
Pro Mixing Paddle  
Floor Display



## LASH® Project Pack

Project Pack includes:  
• 100 1/16"  
Flat Tile Leveling Clips  
• 100 Leveling Wedges



**48**  
Project Packs  
per display



99741D  
LASH® Project Pack  
Floor Display

# LASH XL Tile Leveling Clips and Wedges Pallets

**NEW**

Tile Leveling Clips and Wedges in Pallet quantities

Large Format Design for tiles up to 1/2" thick

Available in 4 grout widths



**16**  
cases  
500 count clips  
per pallet

**4**  
cases  
500 count  
wedges  
per pallet

## 500 Count

Order the following to fill pallets:

**Clips: 16 boxes**

**Wedges: 4 boxes**

See page 32 for details on each sku





# LASH XL Tile Leveling Clips and Wedges Pallets

**NEW**

Tile Leveling Clips and Wedges in Pallet quantities

Large Format Design for tiles up to 1/2" thick Available in 4 grout widths



## 2000 Count Clips



**24**  
cases  
2000 count clips  
per pallet

## 1000 Count Wedges

**24**  
cases  
1000 count  
wedges  
per pallet



Order the following to fill pallets:

Clips: 24 boxes

Wedges: 40 boxes

See page 32 for details on each sku

# LASH<sup>®</sup> 360 Tile Leveling System

Cap and In-line Stem both on one pallet!

Available in 4 grout widths



## Tile Leveling System 48 Count Boxes

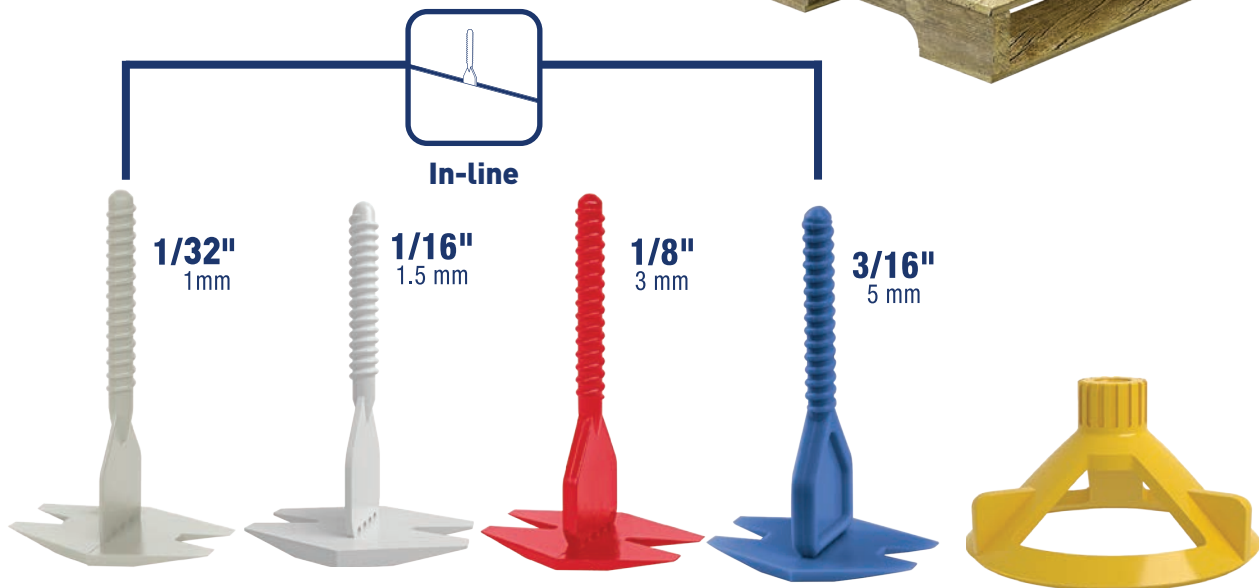

Order the following to fill pallets:

96 count Caps: 24 boxes

240 count Stems: 24 boxes

See page 33 for details on each sku



# Tile Tool Merchandising Displays

QEP is pleased to offer free displays that can be customized based on the product assortment of top-selling tools you carry! These portable gondolas are designed and merchandised to deliver incremental sales at high margins. Includes free branded header insert.

## 4' Tile Tool Merchandising Display



- Header is adjustable and measures 48" wide x 10" tall
- Display measures 48" wide x 26" deep x 72" high

**FREE Display**  
with opening  
order

**\$500**  
Value

See your Sales Rep for more details

QEP 4' Gondola  
Item # QEP4FTGONDOLA  
Sign - Item # 1170-361

← Example of 4' Planogram

## 8' Tile Tool Merchandising Display

- Header is adjustable and measures 96" wide x 10" tall
- Display measures 96" wide x 26" deep x 72" high

**FREE Display**  
with opening  
order

**\$1000**  
Value

See your Sales Rep for more details



QEP 8' Gondola  
Item # QEP8FTGONDOLA  
Sign - Item # 1170-351

Example of 8' Planogram →



## Tile Tool Merchandising Displays

QEP is pleased to offer counter top displays that can be customized based on the product assortment you carry! These displays should be merchandised near check out for incremental sales. All displays includes free branded header insert.

## Counter Display



- Vertical display measures 18.85" wide x 15.68" deep x 33.75" high
- QEP Xtreme Hole Saws are an example of product assortment that can be displayed on this fixture.

Item # HSCTD4W  
Sign # HSCTD4SIGN

**FREE Display**  
with opening  
order

**\$48**  
Value

See your Sales Rep for more details

## Katana Tile Cutter Display



- Display measures 18" wide x 29" deep x 62" high
- Comes with pre printed header sign

Item # TCDSIPLAY

**FREE Display**  
with opening  
order

**\$230**  
Value

See your Sales Rep for more details

# Gravity Display



- Silicone injected hook design allows product to slide to front
- Vertical display measures 27.28" wide x 11.92" deep x 18.70" high
- QEP Xtreme Hole Saws are an example of product assortment that can be displayed on this fixture.

Item # HSCTD5W  
Sign # HSCTD5SIGN

**FREE Display**  
with opening  
order

**\$52**  
Value

See your Sales Rep for more details

# Trowel Shelves



- Display measures 11" wide x 5' deep x 4' high

**FREE Display**  
with opening  
order

**\$30**  
Value

Item # TCDSIPLAY

See your Sales Rep for more details



# STATE-OF-THE-ART FACTORIES

## Specializing in **Automation** and **Large Injection Molding**



## QEP® WARRANTY



All QEP electric tile saws, mixers, tile cutters, and the electric suction cup carry a 3 year Manufacturer's Limited Warranty. The Manufacturer's Limited Warranty ensures the product is free from defects in materials and workmanship for a period of 3-years from the date of purchase. This warranty does not cover accidental damages, unreasonable or improper use, normal wear and tear, loss of use, or consequential damages. Product registration, included with the product packaging, must be completed within 30 days of purchase for eligibility. This warranty covers refund or replacement due to a defect in materials or workmanship for a term of the warranty.

All QEP hand tools carry a 1-year Manufacturer's Limited Warranty ensuring the product is free from defects in materials and workmanship for a period of 1-year from the date of purchase. This warranty does not cover accidental damages, unreasonable or improper use, normal wear and tear, loss of use, or consequential damages.



# INDEX *By Item Number*

Item #	Description	Page
6-1001Q	10" Continuous Rim Diamond Blade- Black Series	29
6-1003Q	10" Continuous Rim Diamond Blade- Gold Series	29
6-1008BW	10" Black Widow® Blade	28
6-4001Q	4" Continuous Rim Diamond Blade- Black Series	29
6-4003Q	4" Continuous Rim Diamond Blade- Gold Series	29
6-4006GLQ	4" Continuous Rim Diamond Blade- Glass Series	29
6-4008BW	4" Black Widow® Blade	28
6-7001Q	7" Continuous Rim Diamond Blade- Black Series	29
6-7003Q	7" Continuous Rim Diamond Blade- Gold Series	29
6-7007GL	7" Continuous Rim Diamond Blade- Glass Series	29
6-7008BW	7" Black Widow® Blade	28
6-8001Q	8" Continuous Rim Diamond Blade- Black Series	29
6-8003Q	8" Continuous Rim Diamond Blade- Gold Series	28
6-8008BW	8" Black Widow® Blade	28
70-195	Aquabar® "B" Moisture Vapor Barrier	75
10003	Tile Nipper	55
10005	1/4" Flexible Tile Spacers, Bag - 200 Qty	35
10010HD	Tungsten Carbide Cutting Wheel	20
10020	Grout Remover	56
10022	Rubbing Stone	56
10027	3/8" Flexible Tile Spacers, Bag - 100 Qty	35
10038	6" Locking Contour Gauge	53
10046	Diamond Sanding Block, 60 grit	47
10047	Diamond Sanding Block, 120 grit	47
10048	Diamond Sanding Block, 200 grit	47
10049	Diamond Sanding Block, 400 grit	47
10051	Xtreme™ 3/8" Diamond Milling Bit	49
10052	Xtreme™ 3/4" Diamond Milling Bit	47
10057	Grout Saw	46
10058	Backerboard Scoring Knife	60
10060	Molded Rubber Grout Float 9-1/2" x 4"	42
10062	Grout Float 9-1/2" x 4"	42
10066	Xtreme™ 3/4" Diamond Milling Cone	47
10069	Xtreme™ Stone Grout Float	41
10070	Gum Rubber Grout Float, Wood Handle	42
10071	Xtreme™ 3/16" Diamond Hole Saw	45
10072	Folding Backerboard Knife	60
10074-8	Universal Float 9-1/2" x 4"	41
10075	Xtreme™ 1/4" Diamond Hole Saw	44
10080	Xtreme™ 5/16" Diamond Hole Saw	44
10087	Xtreme™ 1-3/8" Diamond Hole Saw	44
10088	Diamond Grit Grout Removal Curved Blade	45
10089	Diamond Grit Grout Removal Linear Blade	45

Item #	Description	Page
10093	Pro Grout Saw	48
10103	Xtreme™ Pro Series Offset Tile Nipper	52
10113	Standard Trowel 1/4" x 1/4" x 1/4"	39
10114	Standard Trowel 1/4" x 3/8" x 1/4"	39
10115	Standard Trowel 3/16" x 5/32" V	39
10116	Standard Trowel 1/4" x 3/16" V (Canada Only)	39
10120	Standard Trowel 1/2" x 1/2" x 1/2"	39
10202	1/16" "T" Tile Spacers	35
10203	1/8" "T" Tile Spacers	35
10204	3/16" "T" Tile Spacers	35
10214Q	14" Tile Cutter	19
10220Q	20" Tile Cutter	19
10221Q	21" Tile Cutter	19
10279	Grout Sealer Applicator	57
10285	Wedge Soft Tile Spacers, Bag - 500 Qty	34
10310	Katana™ SR-31 Tile Cutter	15
10320	1/16" Horseshoe Shims - 200 Qty	34
10321	1/8" Horseshoe Shims - 150 Qty	34
10322	3/16" Horseshoe Shims - 100 Qty	34
10323	1/4" Horseshoe Shims - 75 Qty	34
10324	1/16" Hard Leave-In Spacers, Jar - 1500 Qty	35
10325	1/8" Hard Leave-In Spacers, Jar - 1000 Qty	35
10326	3/16" Hard Tile Spacers, Jar - 500 Qty	35
10330-20	1/16" Hard Leave-In Spacers Bag	35
10331-18	1/8" Hard Leave-In Spacers Bag	35
10332	3/16" Hard Leave-In Spacers, Bag - 200 Qty	35
10333	1/4" Hard Leave-In Spacers, Bag - 200 Qty	35
10334	1/16" Flexible Tile Spacers, Bag - 300 Qty	35
10335	1/8" Flexible Tile Spacers, Bag - 500 Qty	35
10336	3/16" Flexible Tile Spacers, Bag - 300 Qty	35
10348	3/16" Hard Wedge Tile Spacer Jar - 500 Qty	35
10410	Katana™ SR-41 Tile Cutter	14
10468	Xtreme™ 3/16" Hole Saw for grinder	45
10469	1/4" Xtreme™ Hole Saw for grinder	45
10470	5/16" Xtreme™ Hole Saw for grinder	45
10471	1" Xtreme™ Hole Saw for grinder	45
10472	1-3/8" Xtreme™ Hole Saw for grinder	45
10473	2" Xtreme™ Hole Saw for grinder	45
10474	2-1/2" Xtreme™ Hole Saw for grinder	45
10475	4" Xtreme™ Hole Saw for grinder	45
10480Q	48" LFT Manual Cutter	18
10485	Xtreme™ Diamond Hole Saw Kit	44
10500	22-1/2" Big Clinker Tile Cutter	16
10569	1-3/8" Porcelain Diamond Hole Saw w/Drill Guide & Water Cooling System	46

Item #	Description	Page
10570	1-3/8" Hole Saw Mounting Tape	46
10571	5/16" Porcelain Diamond Drill Bit w/Drill Guide & Water Cooling System	46
10572	1/4" Porcelain Diamond Drill Bit w/Drill Guide & Water Cooling System	46
10585	3" Diamond Jigsaw Blade	46
10586-6	Diamond Grit File	48
10600	25" Big Clinker Tile Cutter	16
10624Q	24" Slimline Manual Tile Cutter	17
10630	24" Pro Tile Cutter	18
10632Q	30" Slimline Manual Tile Cutter	17
10636Q	36" Slimline Manual Tile Cutter	17
10711	Multi-Use Trim Shears	57
10715	Tile Trim Square	58
10800	28" Big Clinker Tile Cutter	16
10900	35" Pro Tile Cutter	18
19999	Grout Sealer Brush Applicator	57
20839	Large Handle Scrub Brush	64
20842	Grout Cleaning Brush	64
20900Q	14" Surface Scraper	68
20902C	14" Surface Scraper (Canada Only)	68
21000Q	14" Replacement Blade	68
21123Q	7/8" Titanium-Coated Tungsten Carbide Cutting Wheel	20
21125	7/8" Titanium-Coated Tungsten Carbide Cutting Wheel	20
21127Q	10 mm Post Scoring Wheel	20
21178	7/8" Titanium-Coated Tungsten Carbide Cutting Wheel	20
21591	Heavy Duty Multipurpose Gloves	64
21595	SureGrip® Tiler's Gloves (2 pairs of gloves)	64
21661	24" Pro Mixing Paddle	51
21700	Power Mixer Pro w/Paddle	50
22400Q	4" Torque Master XT Portable Wet Tile Saw	27
22700Q	7" 700XT Wet Tile Saw	26
22750Q	7" 750XT Wet Tile Saw	25
22900Q	7" Power Pro 1HP Wet Tile Saw	24
32010	Glass Tile Nipper	52
32014	Xtreme Glass Tile Nipper	52
32024	Tile Cutter	53
32036	Compound Tile Nipper	52
38229	Toilet Installation Kit with 12" Connector	65
38779	Wax China Markers - 2 Pack - 1 black/1 red	53
42112	6" x 2" Comfort Grip Margin Trowel	40
42113-6	Bucket Scoop	40
42114	6" x 2" Comfort Grip Margin Trowel Square Notch 1/4" x 1/4" x 1/4"	40
42117	6" Comfort Grip Margin Float	40
49708	Patch & Finishing Trowel 11" x 4-1/2"	39

Item #	Description	Page
49713	Wood Handle Trowel Square Notch 1/4" x 1/4" x 1/4"	38
49714	Wood Handle Trowel Square Notch 1/4" x 3/8" x 1/4"	38
49716	Wood Handle Trowel V Notch 1/4" x 3/16"	38
49720	Wood Handle Trowel Square Notch 1/2" x 1/2" x 1/2"	38
49915-12	Comfort Grip Stainless Steel Trowel Square Notch 1/4" x 1/4" x 1/4"	38
49916-12	Comfort Grip Stainless Steel Trowel Square Notch 1/4" x 3/8" x 1/4"	38
49917-12	Comfort Grip Stainless Steel Trowel V Notch 3/16" x 5/32"	38
49918-12	Comfort Grip Stainless Steel Trowel Euro Notch (available in Canada)	38
49919-12	Comfort Grip Stainless Steel Trowel Square Notch 1/2" x 1/2" x 1/2"	38
49950-12	Xtreme™ Cork Handle Trowel Square Notch 1/4" x 1/4" x 1/4"	38
49951-12	Xtreme™ Cork Handle Trowel Square Notch 1/4" x 3/8" x 1/4"	38
49952-12	Xtreme™ Cork Handle Trowel Square Notch 1/2" x 1/2" x 1/2"	38
49953-12 (Canada Only)	Xtreme™ Cork Handle Trowel Square Notch with ruler 1/4" x 1/4" x 1/4"	38
49954-12 (Canada Only)	Xtreme™ Cork Handle Trowel Square Notch with ruler 1/4" x 3/8" x 1/4"	38
49955-12 (Canada Only)	Xtreme™ Cork Handle Trowel Square Notch with ruler 1/2" x 1/2" x 1/2"	38
49956-12	12" Xtreme™ Cork Handle Trowel Euro Notch (available in Canada)	38
60240	RC24 Overhead Sliding Tile Saw - 7" Blade	23
61205	23-1/2" Pro Mixing Paddle	51
61205D	23-1/2" Pro Mixing Paddle Floor Display	51
61210	Universal Mixing Paddle	51
61230	30" XL Spiral Pro Mixer	51
61613	White Rubber Mallet	59
61625	Tile Mallet	59
62901	4" Razor Scraper Replacement Blades (5 pack)	70
62904Q	8" Stripper Blade (3 pack)	69
62907Q	8" Stripper Blade (10 pack)	69
62909Q	8" Adjustable Razor Floor Stripper	69
62909QC	8" Adjustable Razor Floor Stripper (10 pack) (Canada Only)	69
62920	4" Razor Scraper	70
62963	Thinset Removal Tool	56
62965Q	Demolition Scraper	69
62971	Xtreme™ Heavy Duty Chisel	70
62972	Chisel Scraper	70
70005	XL All-Purpose Sponge, Bale (Canada Only)	61
70005D	All-Purpose Heavy Duty Single Pack Sponge Floor Display	61
70005Q-6D	All-Purpose Heavy Duty Sponge, Value 6 Pack	61
70005-24	All-Purpose Heavy Duty Sponge, 24 ct Case	61
70005C-24	All-Purpose Heavy Duty Sponge, 36 ct Case (Canada Only)	61
70005-750	All-Purpose Heavy Duty Sponge Bale	61
70005-3VPD	All-Purpose Heavy Duty 3- Pack Sponge Floor Display	61

Item #	Description	Page
70006-18	Pro Square Grouting Sponge	61
70006D	Pro Square Grouting SpongeFloor Display	61
70007-24	Scrubbing Sponge	62
70007C-24	Scrubbing Sponge	62
70010	Microfiber Polishing Sponge	62
70010C-24	Microfiber Polishing Sponge	62
70018	Microfiber Grout Cleaning Cloth 18" x 18"	62
70019	Microfiber Surface Cleaning Cloth 14" x 14" 2-pack	63
72000Q	1/4" Natural Cork 6 mm Roll 200 sq ft	75
72001Q	1/2" Natural Cork 12 mm Sheets 150 sq ft	75
72003Q	1/4" Natural Cork 6 mm Roll 100 sq ft	75
72005Q	1/4" Natural Cork 6 mm 2' x 3' Sheets 30 sq ft	75
73000	Backerboard 1/4" 36" x 60" Full Container Only	59
73001	Backerboard 1/4" 48" x 96" Full Container Only	59
73002	Backerboard 1/2" 36" x 60" Full Container Only	59
73005	Backerboard 1/8" 36" x 60" Full Container Only	59
75000	Suction Cup	55
75001Q	23-1/2" Thinset and Grout Paddle	51
75003	Double Suction Cup	55
75006Q	7" Heavy-Duty Floor Scraper	68
75007Q	7" Replacement Blade	68
75011	Replacement Grout Saw Blades (2 pack)	48
75012	Xtreme™ Pro Series Double Suction Cup	55
75013	ProMAX® GRIP Double Suction Cup	55
75017C	7" Heavy-Duty Floor Scraper with Blade (Canada Only)	68
75021	8" Vacuum Pump Suction Cup	54
75022	8" Pump Suction Cup with Gauge	54
75024	Xtreme™ 8" Electric Suction Cup with Digital LED	54
75025	GPTP™ Rail Cutting System	8-9
75027	GPTP™ Folding Work Table	10
75028	GPTP™ Carrier System	11
75029	GPTP™ Transport Cart	12
75031	GPTP™ Vibrating Suction Cup	12
76000	Grout Bag	57
76030	Polishing Cheesecloth	63
78105	5 Gallon Plastic Mixing Bucket-white with QEP logo	63
78220Q	Tile Installation Kit	65
78220C	Tile Installation Kit (Canada Only)	65
78251	Floor & Wall Tile Installation Kit	65

Item #	Description	Page
79634	Comfort Grip Knee Pads	72
79640	Washable Knee Pads	73
79642	F3 Stabilizer Professional Knee Pads	73
79645	ProMAX® Gel Knee Pads	72
99600	Board Seam Tape	60
99605	Cement Board Seam Tape	60
99703	LASH® Wedges, Box, Qty, 3600	31
96874	LASH® XL Leveling Wedges, Box 1000 Qty	32
99703	LASH® Wedges 3600 Qty Contractor Pack	31
99707Q	LASH® 1/16" Clips 4800 Qty Contractor Pack	31
99726	LASH® Wedges, Bag 100 Qty	31
99727	LASH® Wedges, Box 300 Qty	31
99730	LASH® 1/16" Clips, Bag 100 Qty	31
99731	LASH® 1/16" Clips, Box 300 Qty	31
99734	LASH® 360 Caps, Bag, 100 Qty	33
99735	1/16" LASH® 360 In-line, Bag, 100 Qty	33
99736	1/16" LASH® 360 3-Corner, Bag, 100 Qty	33
99737	1/16" LASH® 360 4-Corner, Bag, 100 Qty	33
99740	LASH® 1/16" Clips, Box 1000 Qty	31
99741D	LASH® Project Pack Floor Display	31
99751	LASH XL™ 1/32" Leveling Clips, Bag 100	32
99761	LASH XL™ 1/16" Leveling Clips, Bag 100 Qty	32
99762	LASH XL™ Leveling Wedges, Bag 100 Qty	32
99763	LASH® XL 3/16" Leveling Clips, Bag, 100 Qty	32
99769	LASH XL™ 3/16" Leveling Clips, Bag 100 Qty	32
99771	LASH XL™ 1/32" Leveling Clips, Box 500 Qty	32
99772	LASH XL™ 1/16" Leveling Clips, Box 500 Qty	32
99773	LASH XL™ 1/8" Leveling Clips, Box 500 Qty	32
99774	LASH XL™ 3/16" Leveling Clips, Box 500 Qty	32
99775	LASH XL™ Leveling Wedges, Box 500 Qty	32
99777	LASH XL™ 1/16" Leveling Clips, Box 2000 Qty	32
99778	LASH XL™ 1/8" Leveling Clips, Box 2000 Qty	32
99779	LASH XL™ 3/16" Leveling Clips, Box 2000 Qty	32
99780	LASH® XL Leveling Wedges, Box 2000 Qty	32
99781	LASH® 1/8" Flat Clips, Bag 100 Qty	31
99782	LASH® 1/8" Flat Clips, Box 300 Qty	31
99783	LASH® 1/8" Flat Clips, Box 1000 Qty	31
99784	Pro Installation Pliers	31
99790	1/16" LASH® Clips, Box, 500 Qty	31
99791	1/8" LASH® Clips, Box, 500 Qty	31



Item #	Description	Page
99792	1/16" LASH® Clips, Box, 2000 Qty	31
99793	1/8" LASH® Clips, Box, 2000 Qty	31
99834	LASH® 360 Caps, Box, 300 Qty	33
99835	1/16" LASH® 360 In-line, Box, 300 Qty	33
99836	1/16" LASH® 360 3-Corner, Box, 300 Qty	33
99837	1/16" LASH® 360 4-Corner, Box, 1000 Qty	33
99838	1/32" LASH® 360 In-line, Box, 1000 Qty	33
99839	1/8" LASH® 360 In-line, Box, 1000 Qty	33
99840	3/16" LASH® 360 In-line, Box, 1000 Qty	33
99861	LASH® XL 1/16" Leveling Clips, Box, 300 Qty	32
99862	LASH® XL Leveling Wedges, Box 300 Qty	32
99869	LASH® XL 1/8" Leveling Clips, Box, 300 Qty	32
99871	LASH® XL LASH XL 1/32" Leveling Clips, Box, 1000 Qty	32
99872	LASH® XL 1/16" Leveling Clips, Box, 1000 Qty	32

Item #	Description	Page
99873	LASH® XL 1/8" Leveling Clips, Box 1000 Qty	32
99971	LASH® XL 1/32" Leveling Clips, Box, 300 Qty	32
QEP8FTGONDOLA	QEP® 8' Gondola	82
1170-351	QEP® 8' Gondola Sign	82
QEP4FTGONDOLA	QEP® 4' Gondola	82
1170-351	QEP® 4' Gondola Sign	82
HSCTD4W	QEP® Counter Display	83
HSCTD4SIGN	QEP® Counter Display Sign	83
HSCTD5W	QEP® Gravity Display Sign	84
HSCTD5SIGN	QEP® Gravity Display Sign	84
SPACER PALLETS	LashXL™ 500 Count Clips and Wedges	79
SPACER PALLETS	LashXL™ 2000 Count Clips and 1000 Count Wedges	80
SPACER PALLETS	LASH® 360 96 Count Caps and 240 Count In-line Stems	81

## About California Proposition 65

Proposition 65 is a California regulatory law that requires businesses to notify California consumers about specific chemicals in the products they purchase so they can make informed decisions about protecting themselves from exposure to these chemicals. This law requires companies to properly label products that contain chemical(s) above certain threshold levels.

As part of QEP Co. Inc.'s continued best business practice and compliance program, we comply with Proposition 65 warning requirements and provide product-associated warnings. We are dedicated to meeting consumer product safety requirements applicable to our products and strive to provide high quality and safe products.

For more information on California Proposition 65, go to [www.P65Warnings.ca.gov](http://www.P65Warnings.ca.gov).

- \*Prop 65 - 1. **⚠️ WARNING:** This product can expose you to chemicals including DEHP which is known to the State of California to cause cancer, birth defects or other reproductive harm.
- \*Prop 65 - 2. **⚠️ WARNING:** This product can expose you to chemicals including N, N-Dimethylformamide, which is known to the State of California to cause cancer, birth defects and other reproductive harm.

QEP®, LASH® and Black Widow® are registered trademarks of QEP Co., Inc.

Aquabar® "B" is a registered trademark of Fortifiber LLC.

Fluidmaster® is a registered trademark of Fluidmaster, Inc.

No-Seep® is a registered trademark of William H. Harvey Co.

ROBERTS® Max Complete® is a registered trademark of Roberts Consolidated Industries, Inc.

Rug Gripper™ is a trademark of Optimum Technologies, Inc.

The products, specifications, and Prop 65 Warnings listed in this catalog are current as of the printed date of this catalog and are subject to change. Access product data sheets, technical bulletins, warranties and SDS documents 24 hours a day, 7 days a week through our continuously updated website.



**QEP**

1001 Broken Sound Parkway, NW  
Boca Raton, Florida 33487

[qep.com](http://qep.com) | [qepcorporate.com](http://qepcorporate.com)

For more information call 866-435-8665

Se habla español

SCAN HERE FOR  
ONLINE CATALOG



PROFESSIONAL  
**TOOLS**  
FOR PROFESSIONAL  
**RESULTS**



QEP TOOLS 2025 – F1825-12461

Our 2025 QEP Catalog Cover Features Bernie Romero and Mario Pino, Sales Managers, demonstrating the GPTP Carrying System.